

MVE - Standard Range

▶ 2 POLES

3000 - 3600 rpm



- II3 D Ex tD A22 Tx IP66
 - TUV NORD Statement Conformity Number TUV 05 ATEX 2768X
 - Equipment and protective system intended for use in potentially explosive atmospheres (Zone 22) - Directive 94/9/EC
 - Compliance with Essential Health and Safety Requirements
 - EN 61241-10



Declaration of conformity "type A" according to:
 - 73/23/EEC - 2006/42/CE - EN 60034-1



- Class II Div.2 Group F,G - T4 - NEMA 4
 - Conform to UL 1836, UL1004 Cert. CSA C22.2 NO100, NO145
 - Intertek ETL - SEMCO File Number 3177001



TYPE	Mechanical Features						Electric Features									
	Working moment		FC		Weight		Power		Current		Ia/In		Class II Div.2	II3 D	Cable Glande	
	Kgcm		Kg		Kg		Kw		A max (Y)				(T)	(°C)		
	50Hz	60Hz	50Hz	60Hz	50Hz	60Hz	50 Hz	60 Hz	50 Hz	60 Hz	50Hz	60Hz	Temp. Class	Temp. Class		
								400V	460V			(T)	(°C)			
MVE 60/3	1.31	0.98	66	71	4.2		0.08	0.09	0.16	0.18	3.0	3.0	T4	100	M16	
MVE 100/3	1.96	1.31	98	95	4.6		0.1	0.11	0.19	0.18	3.0	3.0	T4	100	M16	
MVE 200/3	3.72	2.61	187	189	7.0		0.18	0.21	0.35	0.35	3,3	3.30	T4	100	M20	
MVE 202/3	3.72	2.61	187	189	7.2		0.18	0.21	0.35	0.35	3,3	3.30	T4	100	M20	
MVE 300/3	6.39	4.46	321	323	9.8		0.27	0.28	0.52	0.45	3.60	3.50	T4	100	M20	
MVE 400/3	7.96	5.68	407	411	10.3		0.30	0.36	0.58	0.60	3.50	3.50	T4	100	M20	
MVE 500/3	10.27	7.38	530	534	15.8		0.50	0.58	0.96	0.97	4.00	4.20	T4	100	M20	
MVE 700/3	14.90	10.57	758	765	16.5		0.66	0.75	1.25	1.24	4.30	5.00	T4	100	M20	
MVE 800/3	15.68	11.06	794	800	20.6		0.75	0.90	1.45	1.50	3.80	3.80	T4	100	M20	
MVE 1200/3	20.26	14.00	1005	1013	21.6		0.95	1.15	1.85	1.95	4.40	4.50	T4	100	M20	
MVE 1300/3	27.58	18.86	1355	1365	22.0		1.30	1.38	2.44	2.25	5.20	5.00	T4	100	M20	
MVE 1301/3	27.58	18.86	1355	1365	30.3		1.30	1.38	2.44	2.25	5.20	5.00	T4	100	M20	
MVE 1310/3	22.34	22.34	1123	1616	30.0		1.30	1.38	2.44	2.25	5.20	5.00	T4	100	M20	
MVE 1600/3	31.26	22.22	1601	1608	51.6	51.2	1.57	1.60	2.94	2.61	5.90	6.20	T4	135	M25	
MVE 2000/3	36.78	27.60	2027	1997	52.8	52.0	2.00	2.10	3.75	3.42	6.50	6.40	T4	135	M25	
MVE 2300/3	45.97	31.87	2302	2306	53.6	51.6	2.40	2.45	4.44	3.94	6.00	6.30	T4	135	M25	
MVE 3200/3	68.10	43.89	3252	3176	103.0	101.4	2.90	2.90	5.30	4.61	8.30	8.20	T4	135	M32	
MVE 4000/3	79.40	55.99	4033	4052	107.0	103.8	2.90	2.90	5.30	4.61	8,5	9,7	T4	135	M32	
MVE 5000/3	103.24	69.76	5009	5048	111.2	105.8	4.00	4.00	7.22	6.28	8.50	9.80	T4	135	M32	

TYPE	Mechanical Features						Electric Features									
	Working moment		FC		Weight		Power		Current		Ia/In		Class II Div.2	II3 D	Cable Glande	
	Kgcm		Kg		Kg		Kw		A max (Δ)				(T)	(°C)		
	50Hz	60Hz	50Hz	60Hz	50Hz	60Hz	50 Hz	60 Hz	50 Hz	60 Hz	50Hz	60Hz	Temp. Class	Temp. Class		
								400V	460V			(T)	(°C)			
MVE 6500/3	129.55	90.54	6510	6552	228.4	229.6	5.50	5.50	9.5	8	4.20	5.30	T4	135	M32	
MVE 9000/3	179.59	129.55	9025	9375	240.3	234.7	10.00	9.30	14.00	18.00	5.00	5.00	T4	135	M32	

(*) = Working moment = 2 x static moment

TYPE	Dimensional Features																
	FIG.	Size	C		M		A	B	Ø G	Holes	D	E	F	H	I	L	N
			(mm)		(mm)		(mm)	(mm)	(mm)	n°	(mm)	(mm)	(mm)	(mm)	(mm)	(mm)	(mm)
			50Hz	60Hz	50Hz	60Hz											
MVE 60/3	A	10	211	45	*	*	*	4	130	136	12	48	94	121	85		
MVE 100/3	A	10	211	45	*	*	*	4	130	136	12	48	94	121	85		
MVE 200/3	B	20	219	41	62-74	106	9	4	131	159	15	64	121	123	112		
MVE 202/3	G	23	218	53	**	**	**	4	164	140	25	82	116	159	110		
MVE 300/3	C	30	260	43	***	***	***	4	154	175	15	79	142	163	131		
MVE 400/3	C	30	260	43	***	***	***	4	154	175	15	79	142	163	131		
MVE 500/3	D	40	338	75	105	140	13	4	168	196	22	92	169	178	158		
MVE 700/3	D	40	338	75	105	140	13	4	168	196	22	92	169	178	158		
MVE 800/3	D	50	311	47	120	170	17	4	208	210	22	94	180	205	170		
MVE 1200/3	D	50	311	47	120	170	17	4	208	210	22	94	180	205	170		
MVE 1300/3	D	50	321	47	120	170	17	4	208	210	22	94	180	205	170		
MVE 1301/3	D	53	321	47	100	180	17	4	236	210	26	98	180	205	170		
MVE 1310/3	D	55	321	47	100	200	17	4	236	210	26	98	180	205	170		
MVE 1600/3	D	60	418	83	140	190	17	4	229	247	30	120	247	220	222		
MVE 2000/3	D	60	418	83	140	190	17	4	229	247	30	120	247	220	222		
MVE 2300/3	D	60	418	83	140	190	17	4	229	247	30	120	247	220	222		
MVE 3200/3	D	75	538	115	155	255	25	4	302	318	35	147	295	273	264		
MVE 4000/3	D	75	538	115	155	255	25	4	302	318	35	147	295	273	264		
MVE 5000/3	D	75	588	538	140	115	155	255	25	4	302	318	35	147	295	273	264

TYPE	Dimensional Features																
	FIG.	Size	C		M		A	B	Ø G	Holes	D	E	F	H	I	L	N
			(mm)		(mm)		(mm)	(mm)	(mm)	n°	(mm)	(mm)	(mm)	(mm)	(mm)	(mm)	(mm)
			50Hz	60Hz	50Hz	60Hz											
MVE 6500/3	D	85	605	120	200	320	28	4	385	410	49	199	421	325	378		
MVE 9000/3	D	85	605	120	200	320	28	4	385	410	49	199	421	325	378		

Fig A

A	B	Ø G
mm	mm	mm
62 - 74	106	9
33	83-102	7

Fig G

A	B	Ø G
mm	mm	mm
62 - 74	106	9
65	140	13
115	135	11
135	115	11

Fig C

A	B	Ø G
mm	mm	mm
80	110	11
90	125	13
124	110	11
135	115	11

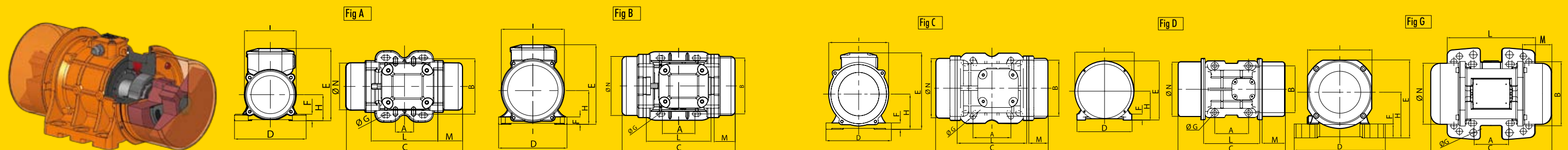

NOTE: Dimensions with coarse degree of accuracy related to UNI 22768/1



- II3 D Ex tD A22 Tx IP66
 - TUV NORD Statement Conformity Number TUV 05 ATEX 2768X
 - Equipment and protective system intended for use in potentially explosive atmospheres (Zone 22) - Directive 94/9/EC
 - Compliance with Essential Health and Safety Requirements
 - EN 61241-10



Declaration of conformity "type A" according to:
 - 73/23/EEC - 2006/42/CE - EN 60034-1



- Class II Div.2 Group F,G - T4 - NEMA 4
 - Conform to UL 1836, UL1004 Cert. CSA C22.2 NO100, NO145
 - Intertek ETL - SEMCO File Number 3177001



TYPE	Mechanical Features						Electric Features								Cable Glande
	Working moment		FC		Weight		Power		Current		Ia/In		Class II Div.2	II3 D	
	Kgcm		Kg		Kg		Kw		A max (Y)				Temp. Class	Temp. Class	
	50Hz	60Hz	50Hz	60Hz	50Hz	60Hz	50 Hz	60 Hz	50 Hz	60 Hz	50Hz	60Hz	(T)	(°C)	
MVE 40/15	2.13	1.47	27	27	4.6		0.04	0.05	0.31	0.31	1.00	1.00	T4	100	M16
MVE 90/15	5.97	4.2	75	76	7.4		0.09	0.1	0.26	0.25	1.00	1.00	T4	100	M20
MVE 200/15	15.44	10.83	194	196	11.8		0.16	0.17	0.49	0.50	1.00	1.00	T4	100	M20
MVE 400/15	33.43	23.38	420	423	19.5		0.30	0.35	0.84	0.86	2.50	2.50	T4	100	M20
MVE 500/15	40.12	28.08	504	508	21.0		0.35	0.40	1.06	1.09	2.80	2.70	T4	100	M20
MVE 300/15	26.58	18.60	334	336	22.5		0.62	0.73	1.32	1.41	3.00	3.20	T4	100	M20
MVE 700/15	56.83	39.36	714	712	27.4		0.62	0.73	1.32	1.41	3.00	3.20	T4	100	M20
MVE 1100/15	88.67	62.02	1114	1122	35.8		0.65	0.78	1.50	1.70	3.80	3.80	T4	100	M20
MVE 1400/15	108.57	76.72	1364	1388	59.8	58.2	0.90	1.10	1.71	1.78	4.00	4.00	T4	135	M25
MVE 1700/15	137.31	91.98	1725	1664	61.8	59.4	1.15	1.30	2.16	2.09	4.70	4.50	T4	135	M25
MVE 2400/15	187.69	137.36	2358	2485	68.0	62.0	1.60	1.90	3.00	3.20	4.90	4.90	T4	135	M25
MVE 2500/15	203.53	135.65	2557	2454	90.0	84.0	1.80	2.00	3.40	3.40	6.00	6.10	T4	135	M25
MVE 3000/15	248.66	169.75	3124	3071	97.5	87.0	1.90	2.30	3.70	3.80	6.50	6.60	T4	135	M25
MVE 3800/15	306.69	204.74	3853	3704	130.4	118.4	2.20	2.60	4.12	4.15	6.80	6.80	T4	135	M32
MVE 4300/15	343.22	240.95	4312	4359	134.4	123.6	2.50	3.00	5.70	5.80	7.00	7.20	T4	135	M32
MVE 5500/15	437.39	303.74	5495	5495	192.2	190.0	3.60	3.45	6.50	6.60	7.10	7.00	T4	135	M32

(*) = Working moment = 2 x static moment

TYPE	Dimensional Features																
	FIG.	Size	C		M		A	B	Ø G	Holes	D	E	F	H	I	L	N
			(mm)		(mm)		(mm)	(mm)	(mm)	n°	(mm)	(mm)	(mm)	(mm)	(mm)	(mm)	(mm)
			50Hz	60Hz	50Hz	60Hz	(mm)	(mm)	(mm)		(mm)	(mm)	(mm)	(mm)	(mm)	(mm)	(mm)
MVE 40/15	A	10	211	45	*	*	*	4	130	136	12	48	94	121	85		
MVE 90/15	B	20	219	41	62-74	106	9	4	131	159	15	64	121	123	112		
MVE 200/15	C	30	260	43	***	***	***	4	154	175	15	79	142	163	131		
MVE 400/15	D	40	338	75	105	140	13	4	168	196	22	92	169	178	158		
MVE 500/15	D	40	338	75	105	140	13	4	168	196	22	92	169	178	158		
MVE 300/15	D	50	311	47	120	170	17	4	208	210	22	94	180	205	170		
MVE 700/15	D	50	397	90	120	170	17	4	208	210	22	94	180	205	170		
MVE 1100/15	D	50	451	112	120	170	17	4	208	210	22	94	180	205	170		
MVE 1400/15	D	60	448	98	140	190	17	4	229	247	30	120	247	220	222		
MVE 1700/15	D	60	448	98	140	190	17	4	229	247	30	120	247	220	222		
MVE 2400/15	D	60	510	448	129	98	140	190	17	4	229	247	30	120	247	220	222
MVE 2500/15	D	70	522	486	123	105	155	225	22	4	272	284	40	140	267	250	235
MVE 3000/15	D	70	522	486	123	105	155	225	22	4	272	284	40	140	267	250	235
MVE 3800/15	D	75	588	538	140	115	155	255	23.5	4	302	318	35	147	295	273	264
MVE 4300/15	D	75	588	140	155	255	23.5	4	302	318	35	147	295	273	264		
MVE 5500/15	D	80	603	130	180	280	26	4	332	360	37	167	345	304	310		

Fig A

A	B	Ø G
62-74	106	9
33	83-102	7

Fig C

A	B	Ø G
80	110	11
90	125	13
124	110	11
135	115	11

NOTE: Dimensions with coarse degree of accuracy related to UNI 22768/1

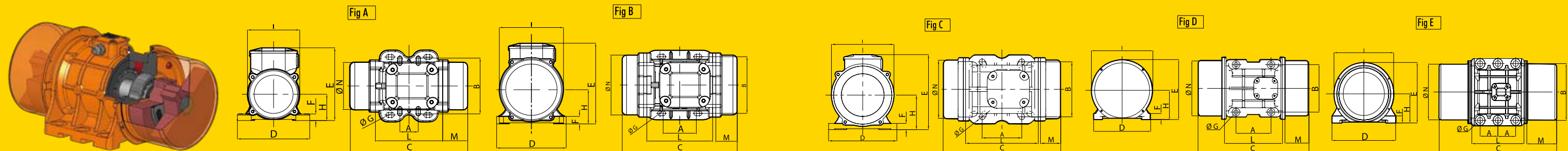

Ex - II3 D Ex tD A22 Tx IP66
 - TUV NORD Statement Conformity Number TUV 05 ATEX 2768X
 - Equipment and protective system intended for use in potentially explosive atmospheres (Zone 22) - Directive 94/9/EC
 - Compliance with Essential Health and Safety Requirements
 - EN 61241-10

CE Declaration of conformity "type A" according to:
 - 73/23/EEC - 2006/42/CE - EN 60034-1
ETL - Class II Div.2 Group F,G - T4 - NEMA 4
 - Conform to UL 1836, UL1004 Cert. CSA C22.2 NO100, NO145
 - Intertek ETL - SEMCO File Number 3177001



TYPE	Mechanical Features						Electric Features										Cable Glande
	Working moment		FC		Weight		Power				Current		Class II Div.2 Temp. Class	Ex II3 D Temp. Class	Cable		
	Kgcm		Kg		Kg		Kw		Hp		A max (Y)					Ia/In	
	50Hz	60Hz	50Hz	60Hz	50Hz	60Hz	50 Hz	60 Hz	50 Hz	60 Hz	50 Hz	60 Hz	50Hz	60Hz	(T)	(°C)	
MVE 50/1	9.49	6.59	53	53	10.4		0.12	0.14	0.16	0.19	0.40	0.40	1.00	1.00	T4	100	M20
MVE 100/1	18.80	13.18	105	106	12.2		0.12	0.14	0.16	0.19	0.40	0.40	1.00	1.00	T4	100	M20
MVE 200/1	33.49	23.38	187	188	19.6		0.18	0.21	0.24	0.28	0.53	0.51	1.00	1.00	T4	100	M20
MVE 300/1	56.93	39.85	318	320	26.6		0.35	0.38	0.47	0.51	0.67	0.64	2.50	2.50	T4	100	M20
MVE 500/1	91.88	64.32	513	517	34.0		0.35	0.40	0.47	0.54	1.20	1.15	2.80	2.70	T4	100	M20
MVE 510/1	91.88	91.88	513	739	34.5		0.35	0.40	0.47	0.54	1.20	1.15	2.80	2.70	T4	100	M20
MVE 800/1	137.37	108.58	767	873	61.8	59.4	0.68	0.76	0.91	1.02	1.29	1.26	2.80	2.80	T4	135	M25
MVE 1100/1	187.69	137.31	1048	1104	79.4	73.0	0.75	0.80	1.01	1.07	1.42	1.32	3.20	3.10	T4	135	M25
MVE 1500/1	284.76	196.51	1590	1580	83.6	76.5	1.10	1.30	1.48	1.74	2.10	2.00	3.30	3.30	T4	135	M25
MVE 1600/1	299.63	203.47	1673	1636	99.8	89.0	1.10	1.30	1.48	1.74	2.83	3.22	3.70	3.60	T4	135	M25
MVE 2100/1	373.05	248.74	2083	2000	114.3	100.5	1.50	1.80	2.01	2.41	3.00	3.00	4.30	4.40	T4	135	M25
MVE 2600/1	467.44	306.70	2610	2466	148.6	131.5	1.96	2.10	2.63	2.82	3.63	3.38	4.80	4.80	T4	135	M32
MVE 3000/1	540.33	379.71	3017	3053	155.4	137.8	2.20	2.40	2.95	3.22	4.50	4.30	5.00	5.00	T4	135	M32
MVE 3800/1	680.38	437.41	3799	3517	215.6	194.8	2.50	3.00	3.35	4.02	4.67	4.88	5.90	6.00	T4	135	M32
MVE 4700/1	838.34	584.17	4681	4697	230.8	212.4	3.20	3.90	4.29	5.23	6.50	6.00	5.50	5.70	T4	135	M32
MVE 5200/1	929.86	654.57	5192	5263	279.8	264.2	3.80	4.00	5.10	5.36	6.92	6.36	5.50	5.50	T4	135	M32
MVE 6500/1	1165.19	823.96	6506	6625	304.4	280.7	4.30	5.00	5.77	6.71	7.76	7.81	6.20	6.00	T4	135	M32

TYPE	Mechanical Features						Electric Features										Cable Glande
	Working moment		FC		Weight		Power				Current		Class II Temp. Class	Ex II3 D Temp. Class	Cable		
	Kgcm		Kg		Kg		Kw		Hp		A max (Δ)					Ia/In	
	50Hz	60Hz	50Hz	60Hz	50Hz	60Hz	50 Hz	60 Hz	50 Hz	60 Hz	50Hz	60Hz	50Hz	60Hz	(T)	(°C)	
MVE 8000/1	1435.98	929.80	8018	7476	325.2	290	7.10	7.50	9.52	10.06	12.60	11.60	6.00	6.20	T4	135	M32
MVE 9000/1	1600.39	1165.23	8936	9369	337.8	307.6	7.50	8.30	10.06	11.13	13.20	12.60	6.30	6.20	T4	135	M32
MVE 10000/1	1788.44	1239.98	9986	9970	385.8	359.3	7.60	8.00	10.19	10.73	13.50	12.70	6.40	6.40	T4	135	M32
MVE 13000/1	2329.84	1647.42	13009	13246	422.2	375.6	10.00	10.00	13.41	13.41	17.00	16.00	6.20	6.2	T4	135	M32

(*) = Working moment = 2 x static moment

TYPE	FIG.	Size	Dimensional Features														
			C (mm)		M (mm)		A (mm)	B (mm)	Ø G (mm)	Holes n°	D (mm)	E (mm)	F (mm)	H (mm)	I (mm)	L (mm)	N (mm)
			50Hz	60Hz	50Hz	60Hz											
MVE 50/1	C	30	260		43		***	***	***	4	154	175	15	79	142	163	131
MVE 100/1	C	30	300		63		***	***	***	4	154	175	15	79	142	163	131
MVE 200/1	D	40	338		75		105	140	13	4	168	196	22	92	169	178	158
MVE 300/1	D	50	397		90		120	170	17	4	208	210	22	94	180	205	170
MVE 500/1	D	50	441		112		120	170	17	4	208	210	22	94	180	205	170
MVE 510/1	D	50	451		112		120	170	17	4	208	210	22	94	180	205	170
MVE 800/1	D	60	448		98		140	190	17	4	229	247	30	120	247	220	222
MVE 1100/1	D	60	510	448	129	98	140	190	17	4	229	247	30	120	247	220	222
MVE 1500/1	D	60	562	510	154	129	140	190	17	4	229	247	30	120	247	220	222
MVE 1600/1	D	70	556	522	140	123	155	225	22	4	272	284	40	140	267	250	235
MVE 2100/1	D	70	616	522	170	123	155	225	22	4	272	284	40	140	267	250	235
MVE 2600/1	D	75	708	588	200	140	155	255	23.5	4	302	318	35	147	295	273	264
MVE 3000/1	D	75	708	608	200	150	155	255	23.5	4	302	318	35	147	295	273	264
MVE 3800/1	D	80	683	603	170	130	180	280	26	4	332	360	37	167	345	304	310
MVE 4700/1	D	80	733	683	195	170	180	280	26	4	332	360	37	167	345	304	310
MVE 5200/1	D	85	685	605	160	120	200	320	28	4	385	410	49	200	422	325	378
MVE 6500/1	D	85	685		160		200	320	28	4	385	410	49	200	422	325	378

TYPE	FIG.	Size	Dimensional Features														
			C (mm)		M (mm)		A (mm)	B (mm)	Ø G (mm)	Holes n°	D (mm)	E (mm)	F (mm)	H (mm)	I (mm)	L (mm)	N (mm)
			50Hz	60Hz	50Hz	60Hz											
MVE 8000/1	D	85	785	685	210	160	200	320	28	4	385	410	49	200	422	325	378
MVE 9000/1	D	85	785	685	210	160	200	320	28	4	385	410	49	200	422	325	378
MVE 10000/1	E	90	826		210		125	380	38	6	452	430	44	204	422	367	378
MVE 13000/1	E	90	926	826	260	210	125	380	38	6	452	430	44	204	422	367	378

NOTE: Dimensions with coarse degree of accuracy related to UNI 22768/1

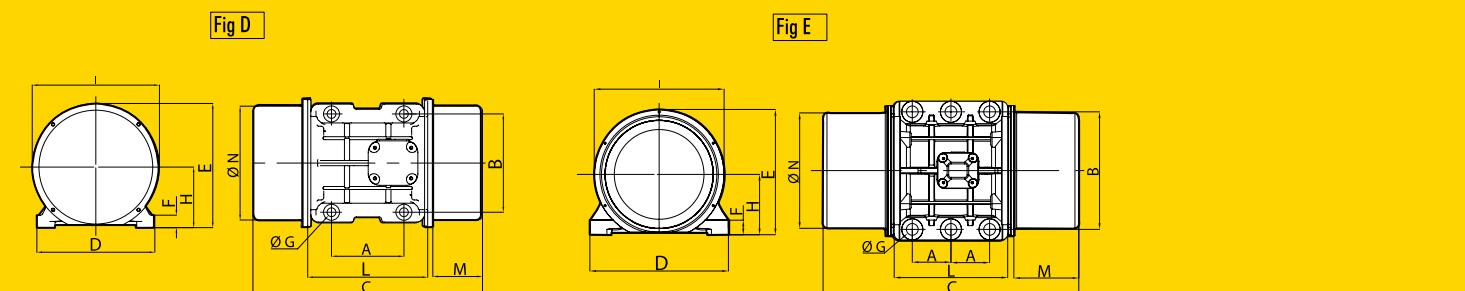
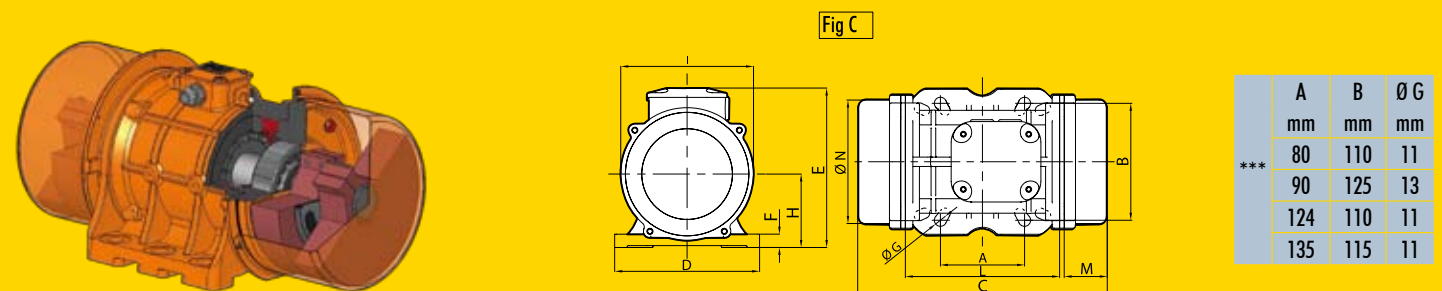



- II3 D Ex tD A22 Tx IP66
 - TUV NORD Statement Conformity Number TUV 05 ATEX 2768X
 - Equipment and protective system intended for use in potentially explosive atmospheres (Zone 22) - Directive 94/9/EC
 - Compliance with Essential Health and Safety Requirements
 - EN 61241-10



Declaration of conformity "type A" according to:
 - 73/23/EEC - 2006/42/CE - EN 60034-1



- Class II Div.2 Group F,G - T4 - NEMA 4
 - Conform to UL 1836, UL1004 Cert. CSA C22.2 NO100, NO145
 - Intertek ETL - SEMCO File Number 3177001



TYPE	Mechanical Features				Electric Features								
	Working moment (*) Kgcm 50Hz - 60Hz	FC Kg		Weight Kg 50Hz - 60Hz	Power Kw		Current A max (Y)		Ia/In		Class II Div.2	II3 D	Cable Glande
		50Hz	60Hz		50 Hz	60 Hz	50Hz	60Hz	Temp. Class (T)	Temp. Class (°C)			
											400V	460V	
MVE 150/075	33.39	105	151	21.4	0.23	0.25	1.14	1.14	1.50	1.50	T4	100	M20
MVE 250/075	56.93	179	257	29.5	0.35	0.38	1.15	1.15	1.70	1.70	T4	100	M20
MVE 400/075	84.02	264	380	35.0	0.35	0.38	1.15	1.15	1.90	1.90	T4	100	M20
MVE 650/075	137.31	431	621	64.7	0.50	0.60	1.20	1.20	2.20	2.20	T4	135	M25
MVE 900/075	187.72	589	849	71.0	0.65	0.78	1.23	1.29	2.50	2.50	T4	135	M25
MVE 1300/075	299.60	941	1355	99.8	1.00	1.10	1.86	1.83	3.00	3.00	T4	135	M25
MVE 2100/075	467.41	1468	2114	150.4	1.50	1.80	2.81	2.89	4.20	4.10	T4	135	M32
MVE 3100/075	680.34	2137	3077	212.2	2.00	2.30	3.79	3.77	4.00	4.00	T4	135	M32
MVE 3800/075	838.43	2633	3792	230.2	2.50	3.00	6.00	6.00	3.90	4.00	T4	135	M32
MVE 4200/075	929.74	2920	4205	284.5	2.90	3.40	6.50	6.50	3.80	3.70	T4	135	M32
MVE 5300/075	1165.22	3660	5270	305	4.00	4.30	8.50	8.00	3.80	4.20	T4	135	M32
MVE 6500/075	1435.85	4510	6494	324.4	5.00	5.90	10.00	10.00	3.60	4.00	T4	135	M32

(*) = Working moment = 2 x static moment

TYPE	Dimensional Features															
	FIG.	Size	C (mm) 50Hz - 60Hz	M (mm) 50Hz - 60Hz	A	B	Ø G	Holes	D	E	F	H	I	L	N	
					(mm)	(mm)	(mm)	n°	(mm)	(mm)	(mm)	(mm)	(mm)	(mm)	(mm)	
MVE 150/075	D	40	338	75	105	140	13	4	168	196	22	92	169	178	158	
MVE 250/075	D	50	397	90	120	170	17	4	208	210	22	94	180	205	170	
MVE 400/075	D	50	441	112	120	170	17	4	208	210	22	94	180	205	170	
MVE 650/075	D	60	448	98	140	190	17	4	229	247	30	120	247	220	222	
MVE 900/075	D	60	510	129	140	190	17	4	229	247	30	120	247	220	222	
MVE 1300/075	D	70	556	140	155	225	22	4	272	284	40	140	267	250	235	
MVE 2100/075	D	75	708	200	155	255	23.5	4	302	318	35	147	295	273	264	
MVE 3100/075	D	80	683	170	180	280	26	4	332	360	37	167	345	304	310	
MVE 3800/075	D	80	733	195	180	280	26	4	332	360	37	167	345	304	310	
MVE 4200/075	D	85	685	160	200	320	28	4	385	410	49	199	422	325	378	
MVE 5300/075	D	85	685	160	200	320	28	4	385	410	49	199	422	325	378	
MVE 6500/075	D	85	785	210	200	320	28	4	385	410	49	199	422	325	378	

NOTE: Dimensions with coarse degree of accuracy related to UNI 22768/1

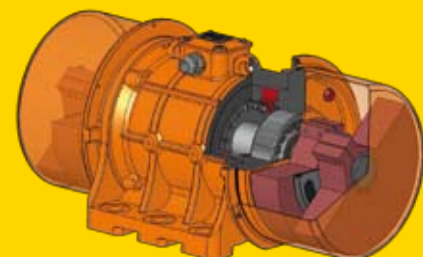

Fig D

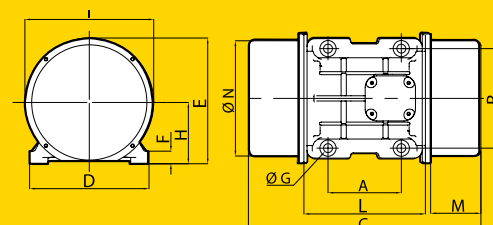
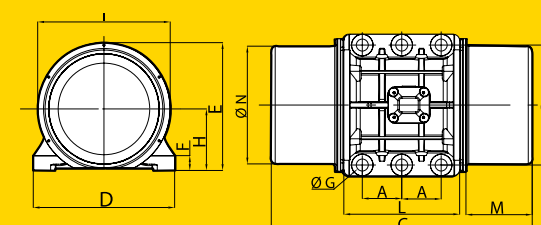

Fig E



MVE - Standard Range

▶ 2 POLES SINGLE PHASE 3000 - 3600 rpm



- II3 D Ex tD A22 Tx IP66
 - TUV NORD Statement Conformity Number TUV 05 ATEX 2768X
 - Equipment and protective system intended for use in potentially explosive atmospheres (Zone 22) - Directive 94/9/EC
 - Compliance with Essential Health and Safety Requirements
 - EN 61241-10



Declaration of conformity "type A" according to:
 - 73/23/EEC - 2006/42/CE - EN 60034-1



- Class II Div.2 Group F,G - T4 - NEMA 4
 - Conform to UL 1836, UL1004 Cert. CSA C22.2 N0100, N0145
 - Intertek ETL - SEMCO File Number 3177001



TYPE	Mechanical Features						Electric Features								
	Working moment		FC		Weight		Power		Current				Class II Div.2	II3 D	Cable
	Kgcm		Kg		Kg		Kw		A max (Y)						
	50Hz	60Hz	50Hz	60Hz	50Hz	60Hz	50 Hz	60 Hz	50 Hz		60 Hz		Temp. Class	Temp. Class	
								230V	115V	50Hz	60Hz	(T)	(°C)	Glande	
MVE 60/3M	1.31	0.98	66	71	4.2		0.08	0.09	0.43	1.03	3.0	3.0	T4	100	M16
MVE 100/3M	1.96	1.31	98	95	4.6		0.1	0.11	0.54	1.3	3.0	3.0			
MVE 200/3M	3.72	2.61	187	189	7.0		0.18	0.21	1.14	2.62	3,3	3.30	T4	100	M20
MVE 202/3M	3.72	2.61	187	189	7.2		0.18	0.21	1.14	2.62	3,3	3.30	T4	100	M20
MVE 300/3M	6.39	4.46	321	323	9.8		0.27	0.28	1.58	3.43	3.60	3.50	T4	100	M20

(*) = Working moment = 2 x static moment

TYPE	FIG.	Size	Dimensional Features														
			C (mm)		M (mm)		A (mm)	B (mm)	Ø G (mm)	Holes n°	D (mm)	E (mm)	F (mm)	H (mm)	I (mm)	L (mm)	N (mm)
			50Hz	60Hz	50Hz	60Hz											
MVE 60/3M	A	10	211		45		*	*	*	4	130	136	12	48	94	121	85
MVE 100/3M	A	10	211		45		*	*	*	4	130	136	12	48	94	121	85
MVE 200/3M	B	20	219		41		62-74	106	9	4	131	159	15	64	121	123	112
MVE 202/3M	G	23	218		53		**	**	**	4	164	140	25	82	116	159	110
MVE 300/3M	C	30	260		43		***	***	***	4	154	175	15	79	142	163	131

NOTE: Dimensions with coarse degree of accuracy related to UNI 22768/1

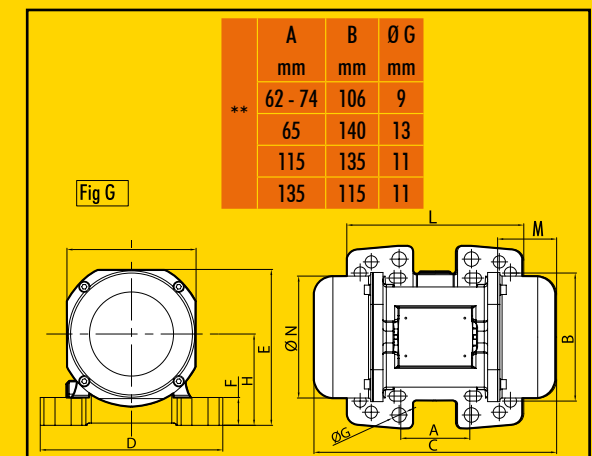
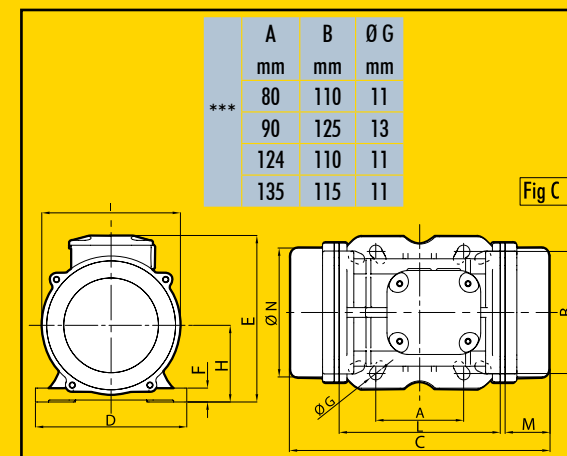
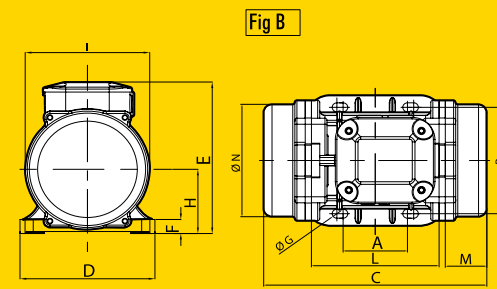
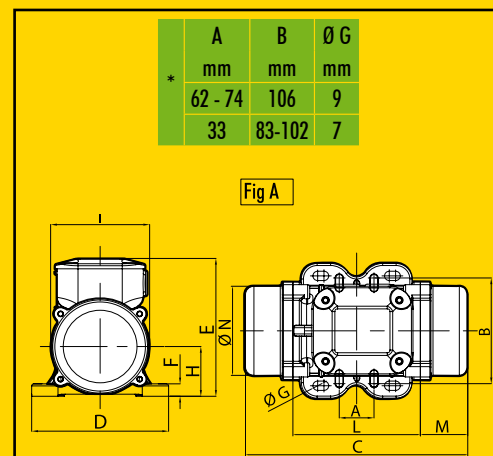
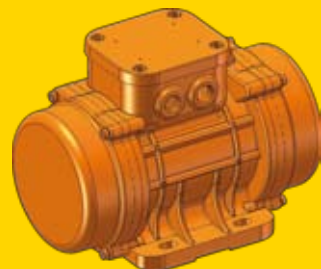

MVE - Standard Range

► MICRO MVE

3000 - 3600 rpm



- I13 D Ex tD A22 Tx IP66
- TUV NORD Statement Conformity Number TUV 05 ATEX 2768X
- Equipment and protective system intended for use in potentially explosive atmospheres (Zone 22) - Directive 94/9/EC
- Compliance with Essential Health and Safety Requirements - EN 61241-10



Declaration of conformity "type A" according to:
- 73/23/EEC - 2006/42/CE - EN 60034-1



- Class II Div.2 Group F,G - T4 - NEMA 4
- Conform to UL 1836, UL1004 Cert. CSA C22.2 N0100, N0145
- Intertek ETL - SEMCO File Number 3177001



THREE PHASE	Mechanical Features						Electric Features						
	Working moment (*)		FC		Weight		Power		Current		Ⓢ	Ⓢ	Cable
	Kgcm		Kg		Kg	Lb	Kw		A max		Class II Div.2	I13 D	
50Hz	60Hz	50Hz	60Hz	50Hz	50Hz	50 Hz	60 Hz	50 Hz	60 Hz	Temp. Class	Temp. Class		
TYPE													Glande
MICRO 20/3	0.44	0.44	22	32	1.5	3.3	0.03	0.04	0.10	0.12	T4	100	M16
MICRO 40/3	0.86	0.86	44	62	1.7	3.7	0.07	0.07	0.25	0.25	T4	100	M16

(*) = Working moment = 2 x static moment

TYPE	Dimensional Features													
	FIG.	C (mm) 50Hz	M (mm) 50Hz	A (mm)	B (mm)	Ø G (mm)	Holes n°	D (mm)	E (mm)	F (mm)	H (mm)	I (mm)	L (mm)	N (mm)
MICRO 20/3	F	145	25	25-40 60	92 85	6.5 6.5	4	110	76.5	10	39	75	74	70.5
MICRO 40/3	F	169	37	25-40 60	92 85	6.5 6.5	4	110	76.5	10	39	75	74	70.5

NOTE: Dimensions with coarse degree of accuracy related to UNI 22768/1

SINGLE PHASE	Mechanical Features						Electric Features						
	Working moment (*)		FC		Weight		Power		Current		Ⓢ	Ⓢ	Cable
	Kgcm		Kg		Kg	Lb	Kw		A max		Class II Div.2	I13 D	
50Hz	60Hz	50Hz	60Hz	50Hz	50Hz	50 Hz	60 Hz	50 Hz	60 Hz	Temp. Class	Temp. Class		
TYPE													Glande
MICRO 4/3 M	0.12	0.12	5	8	1.4	3.1	0.02	0.02	0.3	0.6	T4	100	M16
MICRO 5/3 M	0.12	0.12	5	8	1.4	3.1	0.02	0.02	0.3	0.6	T4	100	M16
MICRO 20/3 M	0.44	0.44	22	32	1.5	3.3	0.03	0.04	0.10	0.23	T4	100	M16
MICRO 40/3 M	0.86	0.86	44	62	1.7	3.7	0.07	0.07	0.40	0.80	T4	100	M16

(*) = Working moment = 2 x static moment

TYPE	Dimensional Features													
	FIG.	C (mm) 50Hz	M (mm) 50Hz	A (mm)	B (mm)	Ø G (mm)	Holes n°	D (mm)	E (mm)	F (mm)	H (mm)	I (mm)	L (mm)	N (mm)
MICRO 4/3 M	F	145	25	25-40 60	92 85	6.5 6.5	4	110	76.5	10	39	75	74	70.5
MICRO 5/3 M	F	145	25	25-40 /	75 /	6.5 /	4	90	76.5	10	39	75	74	70.5
MICRO 20/3 M	F	145	25	25-40 60	92 85	6.5 6.5	4	110	76.5	10	39	75	74	70.5
MICRO 40/3 M	F	169	37	25-40 60	92 85	6.5 6.5	4	110	76.5	10	39	75	74	70.5

NOTE: Dimensions with coarse degree of accuracy related to UNI 22768/1

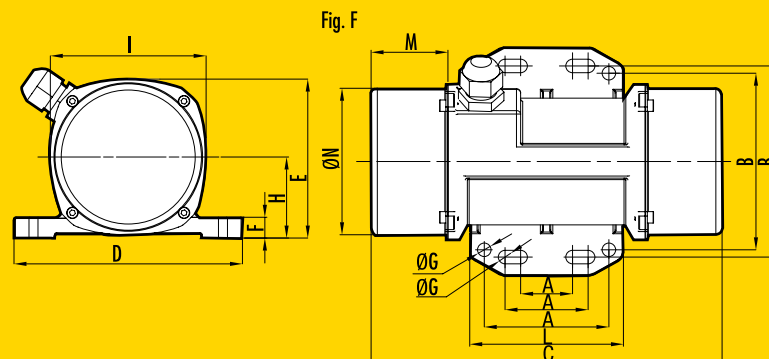
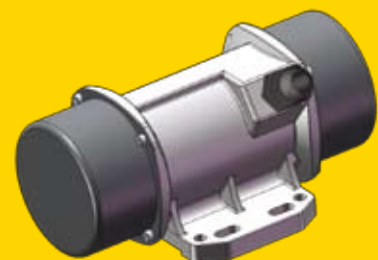



- II3 D Ex tD A22 Tx IP66
 - TUV NORD Statement Conformity Number TUV 05 ATEX 2768X
 - Equipment and protective system intended for use in potentially explosive atmospheres (Zone 22) - Directive 94/9/EC
 - Compliance with Essential Health and Safety Requirements
 - EN 61241-10



Declaration of conformity "type A" according to:
 - 73/23/EEC - 2006/42/CE - EN 60034-1



TYPE	Mechanical Features				Electric Features			
	RPM	Working moment (*) Kgcm	FC Kg	Weight Kg	Power Kw	Current A max	Ex II3 D Temp. Class (°C)	Cable Glande
MVE 202 DC 24	3000	4.17	200	7.2	0.16	6.7	100	M20
MVE 202 DC 12	3000	4.17	200		0.16	13.3	100	M20
MVE 50 DC 24	3000	1.02	50	4.4	0.08	3.3	100	M16
MVE 50 DC 12	3000	1.02	50		0.08	6.6	100	M16

(*) = Working moment = 2 x static moment

TYPE	Dimensional Features														
	FIG.	Size	C (mm) 50Hz	M (mm) 50Hz	A (mm)	B (mm)	Ø G (mm)	Holes n°	D (mm)	E (mm)	F (mm)	H (mm)	I (mm)	L (mm)	N (mm)
MVE 202 DC 24	G	23	218	53	**	**	**	4	164	140	25	82	116	159	110
MVE 202 DC 12	G	23	218	53	**	**	**	4	164	140	25	82	116	159	110
MVE 50 DC 24	A	10	211	45	*	*	*	4	130	136	12	48	94	121	85
MVE 50 DC 12	A	10	211	45	*	*	*	4	130	136	12	48	94	121	85

NOTE: Dimensions with coarse degree of accuracy related to UNI 22768/1

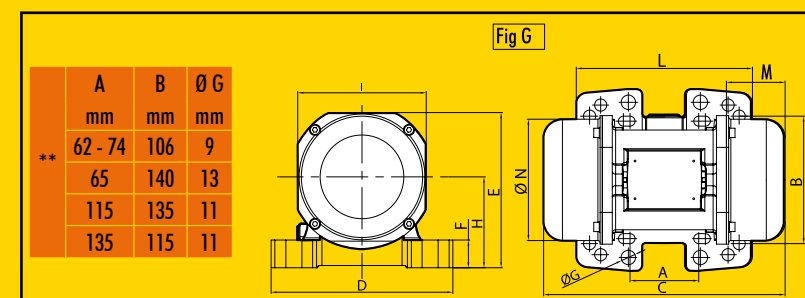
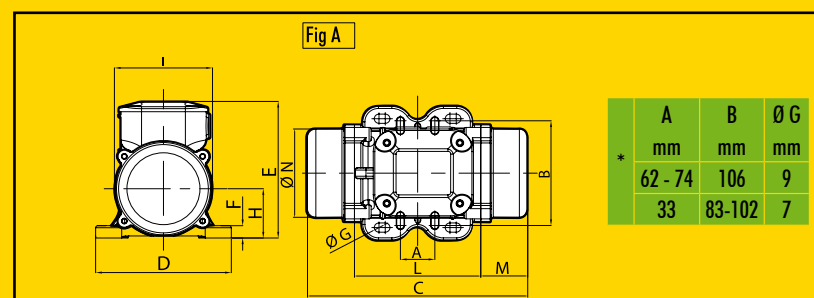

MVE-E Increased Safety Range

▶ 2 POLES

3000 - 3600 rpm

Ex e II T3 Ex tD A21 T1 50°C IP66
II 2 GD
Standard ref.: IEC60079-0; IEC60079-7; IEC61241-0; IEC61241-1

CE Declaration of conformity "type A" according to: 73/23/EEC - 2006/42/CE - EN 60034-1

IEC Standard ref.:
IEC60079-0; IEC60079-7; IEC61241-0; IEC61241-1
IECEX BAS 06.0068X/2

Baseefa Certificate number Baseefa 06ATEX0281X/2



TYPE	Mechanical Features						Electric Features										
	Working moment		FC		Weight		Power		Current		Ex				Cable Glande		
	Kgcm		Kg		Kg		Kw		A max (Y)		Ia/In		t _e			Max Amb	
	50Hz	60Hz	50Hz	60Hz	50Hz	60Hz	50 Hz	60 Hz	50 Hz	60 Hz	50Hz	60Hz	50Hz	60Hz		50Hz	60Hz
								400V		460V		(sec)		(sec)		(°C)	
MVE 200/3E	3.72	2.61	187	189	7.0		0.18	0.21	0.35	0.35	3,3	3.30	18.0	18.0	40.0	40.0	M20
MVE 202/3E	3.72	2.61	187	189	7.2		0.18	0.21	0.35	0.35	3,3	3.30	18.0	18.0	40.0	40.0	M20
MVE 300/3E	6.39	4.46	321	323	9.8		0.27	0.28	0.52	0.45	3.60	3.50	14.0	14.0	40.0	40.0	M20
MVE 400/3E	7.96	5.68	407	411	10.3		0.30	0.36	0.58	0.60	3.50	3.50	15.0	15.0	40.0	40.0	M20
MVE 500/3E	10.27	7.38	530	534	15.8		0.50	0.58	0.96	0.97	4.00	4.20	12.0	11.0	40.0	40.0	M20
MVE 700/3E	14.90	10.57	758	765	16.5		0.66	0.75	1.25	1.24	4.30	5.00	11.0	8.0	40.0	40.0	M20
MVE 800/3E	15.68	11.06	794	800	20.6		0.75	0.90	1.45	1.50	3.80	3.80	12.0	12.0	40.0	40.0	M20
MVE 1200/3E	20.26	14.00	1005	1013	21.6		0.95	1.15	1.85	1.95	4.40	4.50	9.0	9.0	40.0	40.0	M20
MVE 1300/3E	27.58	18.86	1355	1365	22.0		1.30	1.38	2.44	2.25	5.20	5.00	7.5	8.0	40.0	40.0	M20
MVE 1301/3E	27.58	18.86	1355	1365	30.3		1.30	1.38	2.44	2.25	5.20	5.00	7.5	8.0	40.0	40.0	M20
MVE 1310/3E	22.34	22.34	1123	1616	30.0		1.30	1.38	2.44	2.25	5.20	5.00	7.5	8.0	40.0	40.0	M20
MVE 1600/3E	31.26	22.22	1601	1608	51.6	51.2	1.57	1.60	2.94	2.61	5.90	6.20	6.0	6.0	40.0	40.0	M25
MVE 2000/3E	36.78	27.60	2027	1997	52.8	52.0	2.00	2.10	3.75	3.42	6.50	6.40	5.5	5.5	40.0	40.0	M25
MVE 2300/3E	45.97	31.87	2302	2306	53.6	51.6	2.40	2.45	4.44	3.94	6.00	6.30	5.0	5.0	40.0	40.0	M25
MVE 3200/3E	68.10	43.89	3252	3176	103.0	101.4	2.90	2.90	5.30	4.61	8.30	8.20	5.0	5.0	40.0	40.0	M32
MVE 4000/3E	79.40	55.99	4033	4052	107.0	103.8	2.90	2.90	5.30	4.61	8,5	9,7	12,1	6,7	40.0	40.0	M32

(*) = Working moment = 2 x static moment

TYPE	Dimensional Features																
	FIG.	Size	C		M		A	B	Ø G	Holes	D	E	F	H	I	L	N
			(mm)	(mm)	(mm)	(mm)	(mm)	(mm)	(mm)	(mm)	(mm)	(mm)	(mm)	(mm)	(mm)	(mm)	(mm)
MVE 200/3E	B	20	219		41	62-74	106	9	4	131	159	15	64	121	123	112	
MVE 202/3E	G	23	218		53	**	**	**	4	164	140	25	82	116	159	110	
MVE 300/3E	C	30	260		43	***	***	***	4	154	175	15	79	142	163	131	
MVE 400/3E	C	30	260		43	***	***	***	4	154	175	15	79	142	163	131	
MVE 500/3E	D	40	338		75	105	140	13	4	168	196	22	92	169	178	158	
MVE 700/3E	D	40	338		75	105	140	13	4	168	196	22	92	169	178	158	
MVE 800/3E	D	50	311		47	120	170	17	4	208	210	22	94	180	205	170	
MVE 1200/3E	D	50	311		47	120	170	17	4	208	210	22	94	180	205	170	
MVE 1300/3E	D	50	321		47	120	170	17	4	208	210	22	94	180	205	170	
MVE 1301/3E	D	53	321		47	100	180	17	4	236	210	26	98	180	205	170	
MVE 1310/3E	D	55	321		47	100	200	17	4	236	210	26	98	180	205	170	
MVE 1600/3E	D	60	418		83	140	190	17	4	229	247	30	120	247	220	222	
MVE 2000/3E	D	60	418		83	140	190	17	4	229	247	30	120	247	220	222	
MVE 2300/3E	D	60	418		83	140	190	17	4	229	247	30	120	247	220	222	
MVE 3200/3E	D	75	538		115	155	255	25	4	302	318	35	147	295	273	264	
MVE 4000/3E	D	75	538		115	155	255	25	4	302	318	35	147	295	273	264	

NOTE: Dimensions with coarse degree of accuracy related to UNI 22768/1

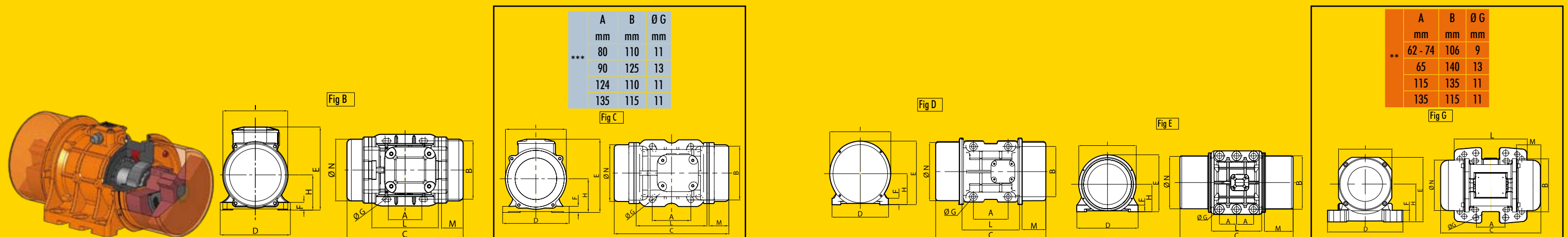

MVE-E Increased Safety Range

► 4 POLES

1500 - 1800 rpm

Ex e II T3 Ex tD A21 T150°C IP66
II 2 GD
Standard ref.: IEC60079-0; IEC60079-7; IEC61241-0; IEC61241-1

CE Declaration of conformity "type A" according to: 73/23/EEC - 2006/42/CE - EN 60034-1

IEC Standard ref.:
IEC60079-0; IEC60079-7; IEC61241-0; IEC61241-1
IECEX BAS 06.0068X/2

Baseefa Certificate number Baseefa 06ATEX0281X/2



TYPE	Mechanical Features						Electric Features										
	Working moment		FC		Weight		Power		Current		Ia/In		t _E		Max Amb		Cable
	Kgc _m		Kg		Kg		Kw		A max (Y)								
	50Hz	60Hz	50Hz	60Hz	50Hz	60Hz	50 Hz	60 Hz	50 Hz	60 Hz	50Hz	60Hz	50Hz	60Hz	50Hz	60Hz	Glande
MVE 200/15E	15.44	10.83	194	196	11.8		0.16	0.17	0.49	0.50	1.00	1.00	60	60	40.0	40.0	
MVE 400/15E	33.43	23.38	420	423	19.5		0.30	0.35	0.84	0.86	2.50	2.50	30	30	40.0	40.0	M20
MVE 500/15E	40.12	28.08	504	508	21.0		0.35	0.40	1.06	1.09	2.80	2.70	22	22	40.0	40.0	M20
MVE 300/15E	26.58	18.60	334	336	22.5		0.62	0.73	1.32	1.41	3.00	3.20	20	19	40.0	40.0	M20
MVE 700/15E	56.83	39.36	714	712	27.4		0.62	0.73	1.32	1.41	3.00	3.20	20	19	40.0	40.0	M20
MVE 1100/15E	88.67	62.02	1114	1122	35.8		0.65	0.78	1.50	1.70	3.80	3.80	12	12	40.0	40.0	M20
MVE 1400/15E	108.57	76.72	1364	1388	59.8		0.90	1.10	1.71	1.78	4.00	4.00	12	12	40.0	40.0	M25
MVE 1700/15E	137.31	91.98	1725	1664	61.8		1.15	1.30	2.16	2.09	4.70	4.50	9	9	40.0	40.0	M25
MVE 2400/15E	187.69	137.36	2358	2485	68.0		1.60	1.90	3.00	3.20	4.90	4.90	8	8	40.0	40.0	M25
MVE 2500/15E	203.53	135.65	2557	2454	90.0		1.80	2.00	3.40	3.40	6.00	6.10	6	6	40.0	40.0	M25
MVE 3000/15E	248.66	169.75	3124	3071	97.5		1.90	2.30	3.70	3.80	6.50	6.60	6	6	40.0	40.0	M25
MVE 3800/15E	306.69	204.74	3853	3704	130.4	118.4	2.20	2.60	4.12	4.15	6.80	6.80	5	5	40.0	40.0	M32
MVE 4300/15E	343.22	240.95	4312	4359	134.4	123.6	2.50	3.00	5.70	5.80	7.00	7.20	5	5	40.0	40.0	M32
MVE 5500/15E	437.39	303.74	5495	5495	192.2	190.0	3.60	3.45	6.50	6.60	7.10	7.00	5	5	40.0	40.0	M32

TYPE	Mechanical Features						Electric Features										
	Working moment		FC		Weight		Power		Current		Ia/In		t _E		Max Amb		Cable
	Kgc _m		Kg		Kg		Kw		A max (Δ)								
	50Hz	60Hz	50Hz	60Hz	50Hz	60Hz	50 Hz	60 Hz	50 Hz	60 Hz	50Hz	60Hz	50Hz	60Hz	50Hz	60Hz	Glande
MVE 7200/15E	576.76	397.32	7246	7188	253.0	246.6	5.00	6.00	9.60	9.41	6.80	6.90	5.00	5.00	40.0	40.0	
MVE 9000/15E	717.97	498.76	9020	9023	268.6	257.8	7.50	8.50	12.00	12.00	7.00	7.00	5.00	5.00	40.0	40.0	M32

TYPE	Dimensional Features																
	FIG.	Size	C		M		A	B	Ø G	Holes	D	E	F	H	I	L	N
			50Hz	60Hz	50Hz	60Hz	(mm)	(mm)	(mm)	n°	(mm)	(mm)	(mm)	(mm)	(mm)	(mm)	(mm)
MVE 200/15E	C	30	260		43		***	***	***	4	154	175	15	79	142	163	131
MVE 400/15E	D	40	338		75		105	140	13	4	168	196	22	92	169	178	158
MVE 500/15E	D	40	338		75		105	140	13	4	168	196	22	92	169	178	158
MVE 300/15E	D	50	311		47		120	170	17	4	208	210	22	94	180	205	170
MVE 700/15E	D	50	397		90		120	170	17	4	208	210	22	94	180	205	170
MVE 1100/15E	D	50	451		112		120	170	17	4	208	210	22	94	180	205	170
MVE 1400/15E	D	60	448		98		140	190	17	4	229	247	30	120	247	220	222
MVE 1700/15E	D	60	448		98		140	190	17	4	229	247	30	120	247	220	222
MVE 2400/15E	D	60	510	448	129	98	140	190	17	4	229	247	30	120	247	220	222
MVE 2500/15E	D	70	522	486	123	105	155	225	22	4	272	284	40	140	267	250	235
MVE 3000/15E	D	70	522	486	123	105	155	225	22	4	272	284	40	140	267	250	235
MVE 3800/15E	D	75	588	538	140	115	155	255	23.5	4	302	318	35	147	295	273	264
MVE 4300/15E	D	75	588		140		155	255	23.5	4	302	318	35	147	295	273	264
MVE 5500/15E	D	80	603		130		180	280	26	4	332	360	37	167	345	304	310

TYPE	Dimensional Features																
	FIG.	Size	C		M		A	B	Ø G	Holes	D	E	F	H	I	L	N
			50Hz	60Hz	50Hz	60Hz	(mm)	(mm)	(mm)	n°	(mm)	(mm)	(mm)	(mm)	(mm)	(mm)	(mm)
	50Hz	60Hz	50Hz	60Hz	(mm)	(mm)	(mm)	n°	(mm)	(mm)	(mm)	(mm)	(mm)	(mm)	(mm)	(mm)	
MVE 7200/15E	D	85	605		120		200	320	28	4	385	410	49	200	422	325	378
MVE 9000/15E	D	85	605		120		200	320	28	4	385	410	49	200	422	325	378

(*) = Working moment = 2 x static moment

NOTE: Dimensions with coarse degree of accuracy related to UNI 22768/1

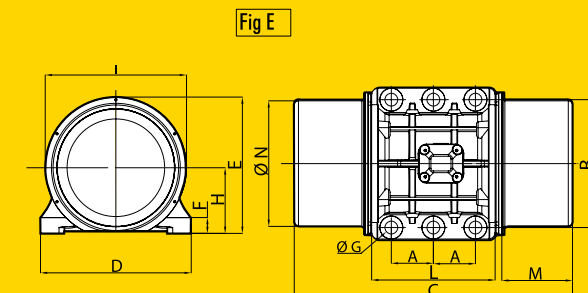
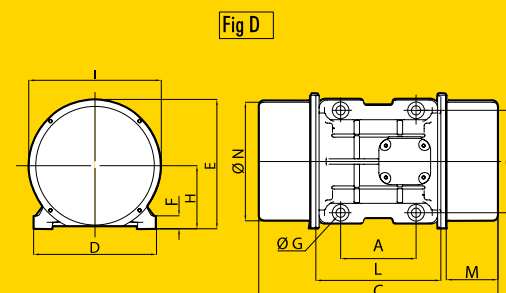
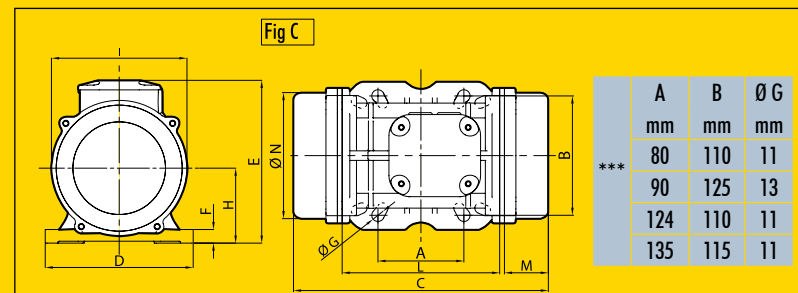
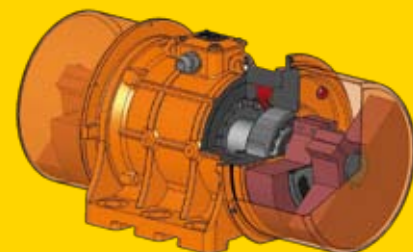

MVE-E Increased Safety Range

6 POLES

1000 - 1200 rpm



Ex e II T3 Ex iD A21 T1 50°C IP66
II 2 GD
Standard ref.: IEC60079-0; IEC60079-7; IEC61241-0; IEC61241-1



Standard ref.:
IEC60079-0; IEC60079-7; IEC61241-0; IEC61241-1
IECEX BAS 06.0068X/2



Declaration of conformity "type A" according to: 73/23/EEC - 2006/42/CE - EN 60034-1



Certificate number Baseefa 06ATEX0281X/2

TYPE	Mechanical Features						Electric Features												Cable Glande
	Working moment		FC		Weight		Power				Current				Ex				
	Kgcm		Kg		Kg		Kw		Hp		A max (Y)		Ia/In		t _e		Max Amb		
	50Hz	60Hz	50Hz	60Hz	50Hz	60Hz	50 Hz	60 Hz	50 Hz	60 Hz	50 Hz	60 Hz	50Hz	60Hz	50Hz	60Hz	50Hz	60Hz	
MVE 50/1E	9.49	6.59	53	53	10.4	0.12	0.14	0.16	0.19	0.40	0.40	1.00	1.00	60.0	60.0	40.0	40.0	M20	
MVE 100/1E	18.80	13.18	105	106	12.2	0.12	0.14	0.16	0.19	0.40	0.40	1.00	1.00	60.0	60.0	40.0	40.0	M20	
MVE 200/1E	33.49	23.38	187	188	19.6	0.18	0.21	0.24	0.28	0.53	0.51	1.00	1.00	60.0	60.0	40.0	40.0	M20	
MVE 300/1E	56.93	39.85	318	320	26.6	0.35	0.38	0.47	0.51	0.67	0.64	2.50	2.50	30.0	30.0	40.0	40.0	M20	
MVE 500/1E	91.88	64.32	513	517	34.0	0.35	0.40	0.47	0.54	1.20	1.15	2.80	2.70	24.0	24.0	40.0	40.0	M20	
MVE 510/1E	91.88	91.88	513	739	34.5	0.35	0.40	0.47	0.54	1.20	1.15	2.80	2.70	24.0	24.0	40.0	40.0	M20	
MVE 800/1E	137.37	108.58	767	873	61.8	0.68	0.76	0.91	1.02	1.29	1.26	2.80	2.80	24.0	24.0	40.0	40.0	M25	
MVE 1100/1E	187.69	137.31	1048	1104	79.4	0.75	0.80	1.01	1.07	1.42	1.32	3.20	3.10	19.0	19.0	40.0	40.0	M25	
MVE 1500/1E	284.76	196.51	1590	1580	83.6	1.10	1.30	1.48	1.74	2.10	2.00	3.30	3.30	16.0	16.0	40.0	40.0	M25	
MVE 1600/1E	299.63	203.47	1673	1636	99.8	1.10	1.30	1.48	1.74	2.83	3.22	3.70	3.60	13.0	13.0	40.0	40.0	M25	
MVE 2100/1E	373.05	248.74	2083	2000	114.3	1.50	1.80	2.01	2.41	3.00	3.00	4.30	4.40	10.0	10.0	40.0	40.0	M25	
MVE 2600/1E	467.44	306.70	2610	2466	148.6	1.96	2.10	2.63	2.82	3.63	3.38	4.80	4.80	9.0	9.0	40.0	40.0	M32	
MVE 3000/1E	540.33	379.71	3017	3053	155.4	2.20	2.40	2.95	3.22	4.50	4.30	5.00	5.00	8.0	8.0	40.0	40.0	M32	
MVE 3800/1E	680.38	437.41	3799	3517	215.6	2.50	3.00	3.35	4.02	4.67	4.88	5.90	6.00	6.0	6.0	40.0	40.0	M32	
MVE 4700/1E	838.34	584.17	4681	4697	230.8	3.20	3.90	4.29	5.23	6.50	6.00	5.50	5.70	7.0	7.0	40.0	40.0	M32	
MVE 5200/1E	929.86	654.57	5192	5263	279.8	3.80	4.00	5.10	5.36	6.92	6.36	5.50	5.50	7.0	7.0	40.0	40.0	M32	
MVE 6500/1E	1165.19	823.96	6506	6625	304.4	4.30	5.00	5.77	6.71	7.76	7.81	6.20	6.00	6.0	6.0	40.0	40.0	M32	
MVE 8000/1E	1435.98	929.80	8018	7476	325.2	7.10	7.50	9.52	10.06	12.60	11.60	6.00	6.20	6.0	6.0	40.0	40.0	M32	
MVE 9000/1E	1600.39	1165.23	8936	9369	337.8	7.50	8.30	10.06	11.13	13.20	12.60	6.30	6.20	5.5	5.5	40.0	40.0	M32	
MVE 10000/1E	1788.44	1239.98	9986	9970	385.8	7.60	8.00	10.19	10.73	13.50	12.70	6.40	6.40	5.5	5.5	40.0	40.0	M32	

(*) = Working moment = 2 x static moment

TYPE	Dimensional Features																
	FIG.	Size	C		M		A	B	Ø G	Holes	D	E	F	H	I	L	N
			(mm)		(mm)		(mm)	(mm)	(mm)	n°	(mm)	(mm)	(mm)	(mm)	(mm)	(mm)	(mm)
			50Hz	60Hz	50Hz	60Hz	50Hz	60Hz									
MVE 50/1E	C	30	260	43	***	***	***	4	154	175	15	79	142	163	131		
MVE 100/1E	C	30	300	63	***	***	***	4	154	175	15	79	142	163	131		
MVE 200/1E	D	40	338	75	105	140	13	4	168	196	22	92	169	178	158		
MVE 300/1E	D	50	397	90	120	170	17	4	208	210	22	94	180	205	170		
MVE 500/1E	D	50	441	112	120	170	17	4	208	210	22	94	180	205	170		
MVE 510/1E	D	50	451	112	120	170	17	4	208	210	22	94	180	205	170		
MVE 800/1E	D	60	448	98	140	190	17	4	229	247	30	120	247	220	222		
MVE 1100/1E	D	60	510	448	129	98	140	190	17	4	229	247	30	120	247	220	222
MVE 1500/1E	D	60	562	510	154	129	140	190	17	4	229	247	30	120	247	220	222
MVE 1600/1E	D	70	556	522	140	123	155	225	22	4	272	284	40	140	267	250	235
MVE 2100/1E	D	70	616	522	170	123	155	225	22	4	272	284	40	140	267	250	235
MVE 2600/1E	D	75	708	588	200	140	155	255	23.5	4	302	318	35	147	295	273	264
MVE 3000/1E	D	75	708	608	200	150	155	255	23.5	4	302	318	35	147	295	273	264
MVE 3800/1E	D	80	683	603	170	130	180	280	26	4	332	360	37	167	345	304	310
MVE 4700/1E	D	80	733	683	195	170	180	280	26	4	332	360	37	167	345	304	310
MVE 5200/1E	D	85	685	605	160	120	200	320	28	4	385	410	49	200	422	325	378
MVE 6500/1E	D	85	685	160	200	320	28	4	385	410	49	200	422	325	378		
MVE 8000/1E	D	85	785	685	210	160	200	320	28	4	385	410	49	200	422	325	378
MVE 9000/1E	D	85	785	685	210	160	200	320	28	4	385	410	49	200	422	325	378
MVE 10000/1E	E	90	826	210	125	380	38	6	452	430	44	204	422	367	378		

NOTE: Dimensions with coarse degree of accuracy related to UNI 22768/1

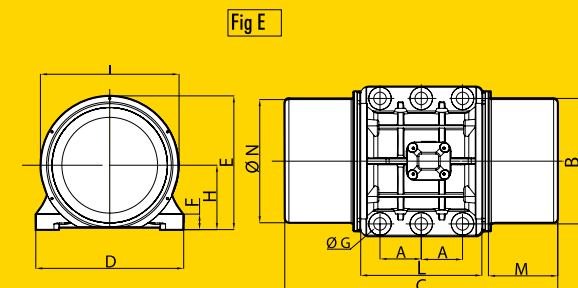
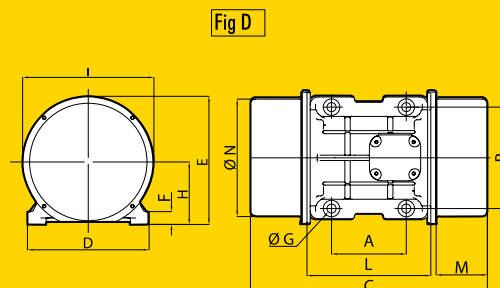
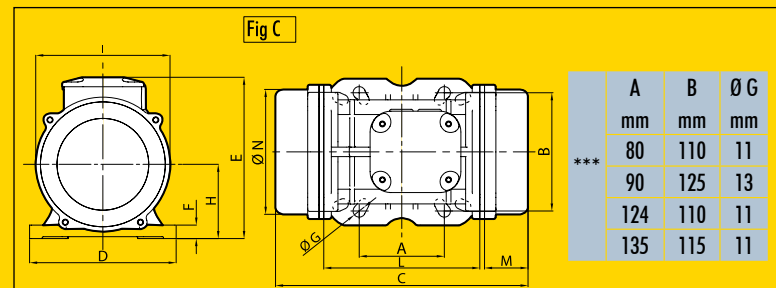
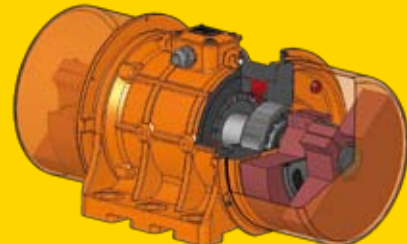

MVE-E Increased Safety Range

► 8 POLES

750 - 900 rpm

Ex e II T3 Ex tD A21 T1 50°C IP66
II 2 GD
Standard ref.: IEC60079-0; IEC60079-7; IEC61241-0; IEC61241-1

CE Declaration of conformity "type A" according to: 73/23/EEC - 2006/42/CE - EN 60034-1

IEC Standard ref.:
IEC60079-0; IEC60079-7; IEC61241-0; IEC61241-1
IECEX BAS 06.0068X/2

Baseefa Certificate number Baseefa 06ATEX0281X/2



TYPE	Mechanical Features				Electric Features										Cable Glande
	Working moment (*) Kgcm 50Hz - 60Hz	FC Kg		Weight Kg 50Hz - 60Hz	Power Kw		Current A max (Y)		Ia/In		t _E		Max Amb		
		50Hz	60Hz		50 Hz	60 Hz	50Hz	60Hz	50Hz	60Hz	50Hz	60Hz	50Hz	60Hz	
MVE 150/075E	33.39	105	151	21.4	0.23	0.25	1.14	1.14	1.50	1.50	30.0	30.0	40.0	40.0	M20
MVE 250/075E	57.27	180	259	29.5	0.35	0.38	1.15	1.15	1.70	1.70	30.0	30.0	40.0	40.0	M20
MVE 400/075E	84.02	264	380	35.0	0.35	0.38	1.15	1.15	1.90	1.90	30.0	30.0	40.0	40.0	M20
MVE 650/075E	137.31	431	621	64.7	0.50	0.60	1.20	1.20	2.20	2.20	30.0	30.0	40.0	40.0	M25
MVE 900/075E	187.72	589	849	71.0	0.65	0.78	1.23	1.29	2.50	2.50	25.0	25.0	40.0	40.0	M25
MVE 1300/075E	299.60	941	1355	99.8	1.00	1.10	1.86	1.83	3.00	3.00	20.0	20.0	40.0	40.0	M25
MVE 2100/075E	467.41	1468	2114	150.4	1.50	1.80	2.81	2.89	4.20	4.10	12.0	12.0	40.0	40.0	M32
MVE 3100/075E	680.34	2137	3077	212.2	2.00	2.30	3.79	3.77	4.00	4.00	12.0	12.0	40.0	40.0	M32
MVE 3800/075E	838.43	2633	3792	230.2	2.50	3.00	6.00	6.00	3.90	4.00	12.0	12.0	40.0	40.0	M32
MVE 4200/075E	929.74	2920	4205	284.5	2.90	3.40	6.50	6.50	3.80	3.70	13.0	13.0	40.0	40.0	M32
MVE 5300/075E	1165.22	3660	5270	305	4.00	4.30	8.50	8.00	3.80	4.20	13.0	12.0	40.0	40.0	M32
MVE 6500/075E	1435.85	4510	6494	324.4	5.00	5.90	10.00	10.00	3.60	4.00	14.0	12.0	40.0	40.0	M32

TYPE	Mechanical Features				Electric Features										Cable Glande
	Working moment (*) Kgcm 50Hz - 60Hz	FC Kg		Weight Kg 50Hz - 60Hz	Power Kw		Current A max (Δ)		Ia/In		t _E		Max Amb		
		50Hz	60Hz		50 Hz	60 Hz	50Hz	60Hz	50Hz	60Hz	50Hz	60Hz	50Hz	60Hz	
MVE 10000/075E	2200.43	6911	9952	422.2	6.80	7.50	13.50	12.5	3.5	4.2	24.8	22.8	40.0	40.0	M32

(*) = Working moment = 2 x static moment

TYPE	Dimensional Features														
	FIG.	Size	C (mm) 50Hz - 60 Hz	M (mm) 50Hz - 60 Hz	A	B	Ø G	Holes	D	E	F	H	I	L	N
					(mm)	(mm)	(mm)	n°	(mm)	(mm)	(mm)	(mm)	(mm)	(mm)	(mm)
MVE 150/075E	D	40	338	75	105	140	13	4	168	196	22	92	169	178	158
MVE 250/075E	D	50	397	90	120	170	17	4	208	210	22	94	180	205	170
MVE 400/075E	D	50	441	112	120	170	17	4	208	210	22	94	180	205	170
MVE 650/075E	D	60	448	98	140	190	17	4	229	247	30	120	247	220	222
MVE 900/075E	D	60	510	129	140	190	17	4	229	247	30	120	247	220	222
MVE 1300/075E	D	70	556	140	155	225	22	4	272	284	40	140	267	250	235
MVE 2100/075E	D	75	708	200	155	255	23.5	4	302	318	35	147	295	273	264
MVE 3100/075E	D	80	683	170	180	280	26	4	332	360	37	167	345	304	310
MVE 3800/075E	D	80	733	195	180	280	26	4	332	360	37	167	345	304	310
MVE 4200/075E	D	85	685	160	200	320	28	4	385	410	49	199	422	325	378
MVE 5300/075E	D	85	685	160	200	320	28	4	385	410	49	199	422	325	378
MVE 6500/075E	D	85	785	210	200	320	28	4	385	410	49	199	422	325	378

TYPE	Dimensional Features														
	FIG.	Size	C (mm) 50Hz - 60 Hz	M (mm) 50Hz - 60 Hz	A	B	Ø G	Holes	D	E	F	H	I	L	N
					(mm)	(mm)	(mm)	n°	(mm)	(mm)	(mm)	(mm)	(mm)	(mm)	(mm)
MVE 10000/075E	E	90	926	260	125	380	38	6	452	430	44	204	422	367	378

NOTE: Dimensions with coarse degree of accuracy related to UNI 22768/1

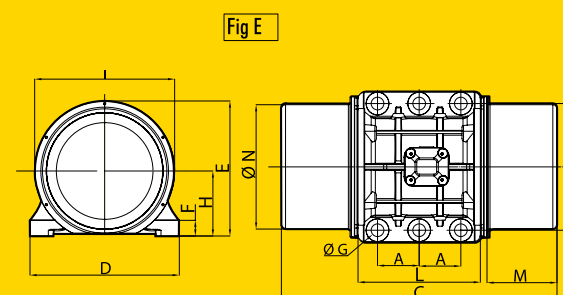
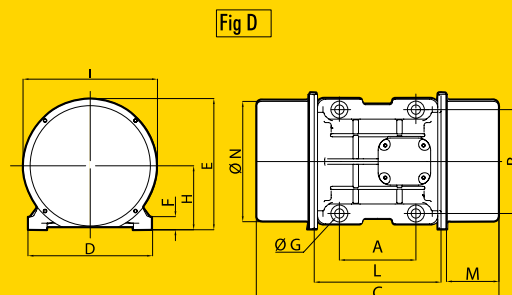
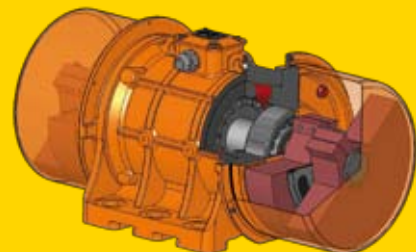

MVE-D Explosion Proof Range

▶ 2 POLES

3000 - 3600 rpm

CE Declaration of conformity "type A" according to: 73/23/EEC - 2006/42/CE - EN 60034-1

Ex II 2 GD Exd IIB T4 Ex tD A21 IP66 T135°C
 Ex d IIB T4 Gb
 Ex tD A21 IIIC T135°C Db IP66
 Standard ref.: IEC60079-0; IEC60079-1; IEC61241-0; IEC 61241-1

IEC Standard ref.:
 IEC60079-0; IEC60079-7; IEC61241-0; IEC61241-1
 IECEx BAS 06.0068X/2

IEC Cert. no: TUV 08 ATEX 362386 X



TYPE	Mechanical Features						Electric Features								
	Working moment		FC		Weight		Power		Current		Ia/In		Ex		Cable Glande
	Kgcm		Kg		Kg		Kw		A max (Y)						
	50Hz	60Hz	50Hz	60Hz	50Hz	60Hz	50 Hz	60 Hz	50 Hz	60 Hz	50Hz	60Hz	Dust	Gas	
								400V 460V				(°C)	T		
MVE 800/3D	15.68	11.06	794	800	29.0		0.75	0.90	1.45	1.50	3.80	3.80	135	T4	M20
MVE 1300/3D	27.58	18.86	1355	1365	30.4		1.30	1.38	2.44	2.25	5.20	5.00	135	T4	M20
MVE 1600/3D	31.26	22.22	1601	1608	60.0	59.6	1.57	1.60	2.94	2.61	5.90	6.20	135	T4	M25
MVE 2000/3D	36.78	27.60	2027	1997	61.2	60.4	2.00	2.10	3.75	3.42	6.50	6.40	135	T4	M25
MVE 2300/3D	45.97	31.87	2302	2306	62.0	60.0	2.40	2.45	4.44	3.94	6.00	6.30	135	T4	M25
MVE 3200/3D	68.10	43.89	3252	3176	111.4	109.8	2.90	2.90	5.30	4.61	8.30	8.20	135	T4	M32
MVE 4000/3D	79.40	55.99	4033	4052	115.4	111.4	2.90	2.90	5.30	4.61	8,5	9,7	135	T4	M32

(*) = Working moment = 2 x static moment

TYPE	Dimensional Features														
	FIG.	Size	C (mm) 50Hz - 60 Hz	M (mm) 50Hz - 60 Hz	A	B	Ø G	Holes	D	E	F	H	I	L	N
					(mm)	(mm)	(mm)	n°	(mm)	(mm)	(mm)	(mm)	(mm)	(mm)	(mm)
MVE 800/3D	A	50	335	65	120	170	17	4	209	240	28	103	195	205	166.5
MVE 1300/3D	A	50	335	65	120	170	17	4	209	240	28	103	195	205	166.5
MVE 1600/3D	A	60	478	105	140	190	17	4	234	267	31	124	238	234	222
MVE 2000/3D	A	60	478	105	140	190	17	4	234	267	31	124	238	234	222
MVE 2300/3D	A	63	478	105	140	190	22	4	234	267	31	124	238	234	222
MVE 3200/3D	A	75	569	115	155	255	23.5	4	300	321	35	147	285	298	265
MVE 4000/3D	A	75	569	115	155	255	23.5	4	300	321	35	147	285	298	265

NOTE: Dimensions with coarse degree of accuracy related to UNI 22768/1

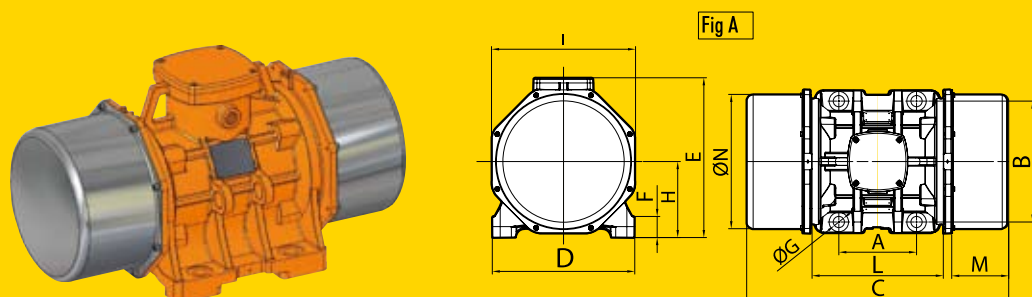

MVE-D Explosion Proof Range

▶ 4 POLES

1500 - 1800 rpm

CE Declaration of conformity "type A" according to: 73/23/EEC - 2006/42/CE - EN 60034-1

Ex II 2 GD Exd IIB T4 Ex tD A21 IP66 T135°C
 Ex d IIB T4 Gb
 Ex tD A21 IIIC T135°C Db IP66
 Standard ref.: IEC60079-0; IEC60079-1; IEC61241-0; IEC 61241-1

IEC Standard ref.:
 IEC60079-0; IEC60079-7; IEC61241-0; IEC61241-1
 IECEx BAS 06.0068X/2

Cert. no: TUV 08 ATEX 362386 X



TYPE	Mechanical Features						Electric Features										
	Working moment		FC		Weight		Power				Current		Ia/In		Ex		Cable Glande
	Kgcm		Kg		Kg		Kw		Hp		A max (Y)				Dust (°C)	Gas T	
	50Hz	60Hz	50Hz	60Hz	50Hz	60Hz	50 Hz	60 Hz	50 Hz	60 Hz	50 Hz	60 Hz	50Hz	60Hz			
MVE 700/15D	56.83	39.36	714	712	35.8		0.62	0.73	0.83	0.98	1.32	1.41	3.00	3.20	135	T4	M20
MVE 1100/15D	88.67	56.83	1114	1028	44.2	39.2	0.65	0.78	0.87	1.05	1.50	1.70	3.80	3.80	135	T4	M20
MVE 1400/15D	108.57	76.72	1364	1388	68.2	66.6	0.90	1.10	1.21	1.48	1.71	1.78	4.00	4.00	135	T4	M25
MVE 1700/15D	137.31	91.98	1725	1664	70.2	67.8	1.15	1.30	1.54	1.74	2.16	2.09	4.70	4.50	135	T4	M25
MVE 2400/15D	187.69	137.36	2358	2485	76.4	70.4	1.60	1.90	2.15	2.55	3.00	3.20	4.90	4.90	135	T4	M25
MVE 2500/15D	203.53	135.65	2557	2454	98.4	92.4	1.80	2.00	2.41	2.68	3.40	3.40	6.00	6.10	135	T4	M25
MVE 3000/15D	248.66	169.75	3124	3071	105.9	95.4	1.90	2.30	2.55	3.08	3.70	3.80	6.50	6.60	135	T4	M25
MVE 3800/15D	306.69	204.74	3853	3704	138.4	126.8	2.20	2.60	2.95	3.49	4.12	4.15	6.80	6.80	135	T4	M32
MVE 3810/15D	306.69	204.74	3853	3704	140.5	128.9	2.20	2.60	2.95	3.49	4.12	4.15	6.80	6.80	135	T4	M32
MVE 4300/15D	343.22	240.95	4312	4359	142.8	132.0	2.50	3.00	3.35	4.02	5.70	5.80	7.00	7.20	135	T4	M32
MVE 5500/15D	437.39	303.74	5495	5495	200.6	198.4	3.60	3.45	4.83	4.63	6.50	6.60	7.10	7.00	135	T4	M32

TYPE	Dimensional Features																
	FIG.	Size	C (mm)		M (mm)		A (mm)	B (mm)	Ø G (mm)	Holes n°	D (mm)	E (mm)	F (mm)	H (mm)	I (mm)	L (mm)	N (mm)
			50Hz	60Hz	50Hz	60Hz											
MVE 700/15D	A	50	405		100		120	170	17	4	209	240	28	103	195	205	167
MVE 1100/15D	A	50	467	405	131	100	120	170	17	4	209	240	28	103	195	205	167
MVE 1400/15D	A	60	478		105		140	190	17	4	234	267	31	124	238	234	222
MVE 1700/15D	A	63	478		105		140	190	22	4	234	267	31	124	238	234	222
MVE 2400/15D	A	63	538		135		140	190	22	4	234	267	31	124	238	234	222
MVE 2500/15D	A	70	526		115		155	225	22	4	274	309	35	140	255	264	236
MVE 3000/15D	A	70	590		147		155	225	22	4	274	309	35	140	255	264	236
MVE 3800/15D	A	75	619		140		155	255	23.5	4	300	321	35	147	285	304	265
MVE 3810/15D	B	77	619		140		105	248	22	6	300	321	35	147	285	304	265
MVE 4300/15D	A	75	619		140		155	255	23.5	4	300	321	35	147	285	304	265
MVE 5500/15D	A	80	613		135		180	280	26	4	330	370	50	176	334	304	311

(*) = Working moment = 2 x static moment

NOTE: Dimensions with coarse degree of accuracy related to UNI 22768/1

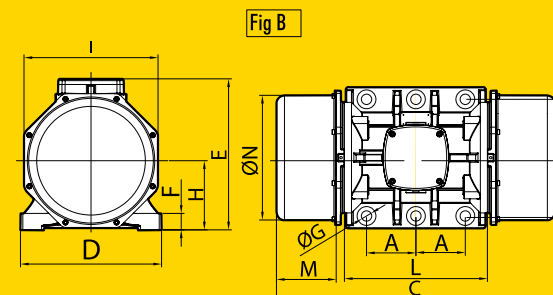
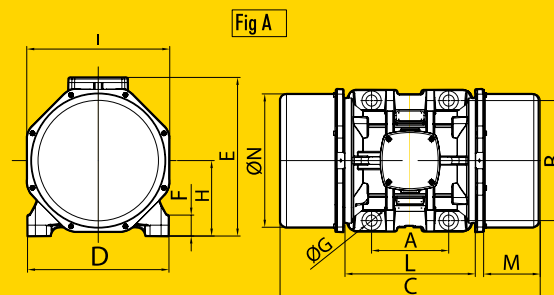
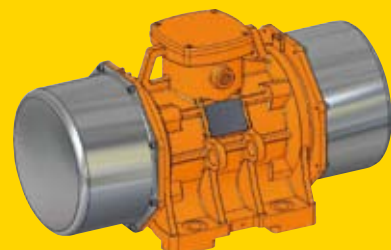

MVE-D Explosion Proof Range

▶ 6 POLES

1000 - 1200 rpm

CE Declaration of conformity "type A" according to: 73/23/EEC - 2006/42/CE - EN 60034-1

Ex II 2 GD Exd IIB T4 Ex tD A21 IP66 T135°C
 Ex d IIB T4 Gb
 Ex tD A21 IIIC T135°C Db IP66
 Standard ref.: IEC60079-0; IEC60079-1; IEC61241-0; IEC 61241-1

IEC Standard ref.:
 IEC60079-0; IEC60079-7; IEC61241-0; IEC61241-1
 IECEx BAS 06.0068X/2

Cert. no: TUV 08 ATEX 362386 X



TYPE	Mechanical Features						Electric Features										
	Working moment		FC		Weight		Power				Current		Ia/In		Ex		Cable
	Kgcm		Kg		Kg		Kw		Hp		A max (Y)				Dust (°C)	Gas T	
	50Hz	60Hz	50Hz	60Hz	50Hz	60Hz	50 Hz	60 Hz	50 Hz	60 Hz	50 Hz	60 Hz	50Hz	60Hz			
MVE 500/1D	91.88	91.88	513	739	34.0		0.35	0.4	0.5	0.5	1.2	1.2	2.8	2.7	135	T4	M20
MVE 800/1D	137	109	767	873	70.2	67.8	0.7	0.8	0.9	1.0	1.3	1.3	2.8	2.8	135	T4	M25
MVE 1100/1D	188	137	1048	1104	87.8	81.4	0.8	0.8	1.0	1.1	1.4	1.3	3.2	3.1	135	T4	M25
MVE 1500/1D	285	197	1590	1580	92.0	84.9	1.1	1.3	1.5	1.7	2.1	2.0	3.3	3.3	135	T4	M25
MVE 1600/1D	300	203	1673	1636	108.4	97.4	1.1	1.3	1.5	1.7	2.8	3.2	3.7	3.6	135	T4	M25
MVE 2100/1D	373	249	2083	2000	122.7	108.9	1.5	1.8	2.0	2.4	3.0	3.0	4.3	4.4	135	T4	M25
MVE 2600/1D	467	307	2610	2466	157.0	139.9	2.0	2.1	2.6	2.8	3.6	3.4	4.8	4.8	135	T4	M32
MVE 3000/1D	540	380	3017	3053	163.8	146.2	2.2	2.4	3.0	3.2	4.5	4.3	5.0	5.0	135	T4	M32
MVE 3800/1D	680	437	3799	3517	224.0	203.2	2.5	3.0	3.4	4.0	4.7	4.9	5.9	6.0	135	T4	M32
MVE 4700/1D	838	584	4681	4697	239.2	220.8	3.2	3.9	4.3	5.2	6.5	6.0	5.5	5.7	135	T4	M32

TYPE	Dimensional Features																
	FIG.	Size	C (mm)		M (mm)		A (mm)	B (mm)	Ø G (mm)	Holes n°	D (mm)	E (mm)	F (mm)	H (mm)	I (mm)	L (mm)	N (mm)
			50Hz	60Hz	50Hz	60Hz											
MVE 500/1D	A	50	467		131	120	170	17	4	209	240	28	103	195	205	166.5	
MVE 800/1D	A	60	478		105	140	190	17	4	234	267	31	124	238	234	222	
MVE 1100/1D	A	63	538		135	140	190	22	4	234	267	31	124	238	234	222	
MVE 1500/1D	A	60	598		165	140	190	17	4	234	267	31	124	238	234	222	
MVE 1600/1D	A	70	590		147	155	225	22	4	274	309	35	140	255	264	236	
MVE 2100/1D	A	70	650		177	155	225	22	4	274	309	35	140	255	264	236	
MVE 2600/1D	A	75	739		200	155	255	23.5	4	300	321	35	147	285	304	265	
MVE 3000/1D	A	75	739		200	155	255	23.5	4	300	321	35	147	285	304	265	
MVE 3800/1D	A	80	693		175	180	280	26	4	330	370	50	176	334	304	311	
MVE 4700/1D	A	80	753		205	180	280	26	4	330	370	50	176	334	304	311	

(*) = Working moment = 2 x static moment

NOTE: Dimensions with coarse degree of accuracy related to UNI 22768/1

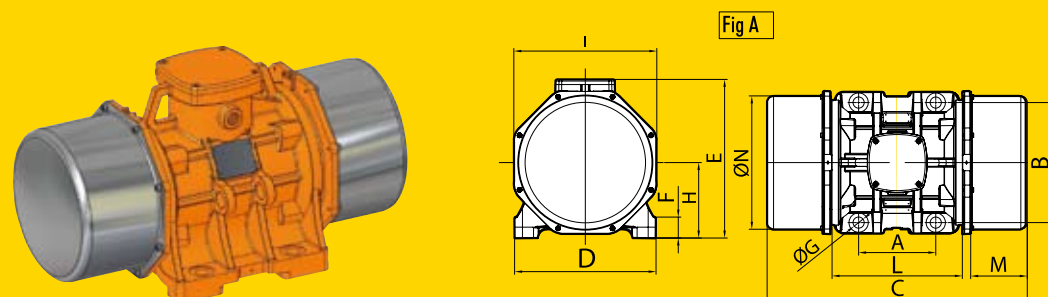

MVE-D Explosion Proof Range

▶ 8 POLES

750 - 900 rpm

CE Declaration of conformity "type A" according to: 73/23/EEC - 2006/42/CE - EN 60034-1

Ex II 2 GD Exd IIB T4 Ex tD A21 IP66 T135°C
 Ex d IIB T4 Gb
 Ex tD A21 IIIC T135°C Db IP66
 Standard ref.: IEC60079-0; IEC60079-1; IEC61241-0; IEC 61241-1

IEC Standard ref.:
 IEC60079-0; IEC60079-7; IEC61241-0; IEC61241-1
 IECEx BAS 06.0068X/2

Cert. no: TUV 08 ATEX 362386 X



TYPE	Mechanical Features					Electric Features								Cable Glande
	Working moment (*) Kgcm 50Hz - 60Hz	FC		Weight		Power		Current		Ia/In		Ex		
		Kg	Kg	Kg	Lb	Kw	60 Hz	A max (Y)		50Hz	60Hz	Dust (°C)	Gas T	
								50Hz	60 Hz					
MVE 250/075D	57.27	180	259	37.9	83.6	0.35	0.38	1.15	1.15	1.70	1.70	135	T4	M20
MVE 400/075D	84.02	264	380	43.4	95.7	0.35	0.38	1.15	1.15	1.90	1.90	135	T4	M20
MVE 650/075D	137.31	431	621	73.1	161.2	0.50	0.60	1.20	1.20	2.20	2.20	135	T4	M25
MVE 900/075D	187.72	589	849	79.4	175.0	0.65	0.78	1.23	1.29	2.50	2.50	135	T4	M25
MVE 1300/075D	299.60	941	1355	108.2	238.5	1.00	1.10	1.86	1.83	3.00	3.00	135	T4	M25
MVE 2100/075D	467.41	1468	2114	158.8	350.1	1.50	1.80	2.81	2.89	4.20	4.10	135	T4	M32
MVE 3100/075D	680.34	2137	3077	220.6	486.3	2.00	2.30	3.79	3.77	4.00	4.00	135	T4	M32
MVE 3800/075D	838.43	2633	3792	238.6	526.0	2.50	3.00	6.00	6.00	3.90	4.00	135	T4	M32

(*) = Working moment = 2 x static moment

TYPE	Dimensional Features														
	FIG.	Size	C (mm) 50Hz - 60 Hz	M (mm) 50Hz - 60 Hz	A	B	Ø G	Holes	D	E	F	H	I	L	N
					(mm)	(mm)	(mm)	n°	(mm)	(mm)	(mm)	(mm)	(mm)	(mm)	(mm)
MVE 250/075D	A	50	405	100	120	170	17	4	209	240	28	103	195	205	167
MVE 400/075D	A	50	467	131	120	170	17	4	209	240	28	103	195	205	167
MVE 650/075D	A	60	478	105	140	190	17	4	234	267	31	124	238	234	222
MVE 900/075D	A	63	538	135	140	190	22	4	234	267	31	124	238	234	222
MVE 1300/075D	A	70	590	147	155	225	22	4	274	309	35	140	255	264	236
MVE 2100/075D	A	75	739	200	155	255	23.5	4	300	321	35	147	285	304	265
MVE 3100/075D	A	80	743	200	180	280	26	4	330	370	50	176	334	304	311
MVE 3800/075D	A	80	743	200	180	280	26	4	330	370	50	176	334	304	311

NOTE: Dimensions with coarse degree of accuracy related to UNI 22768/1

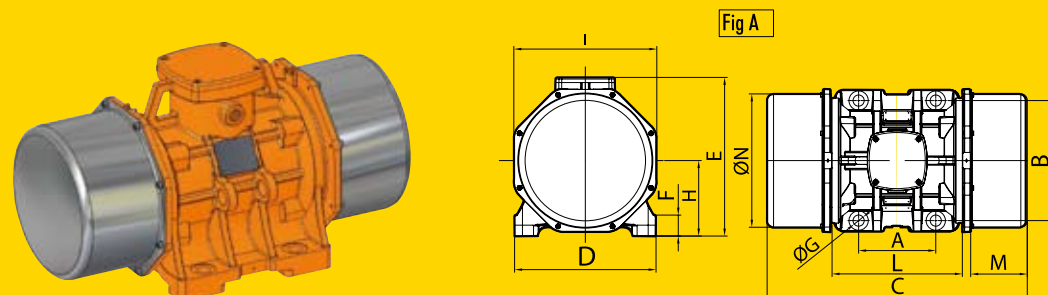

TYPE	Mechanical Features						Electric Features							
	Working moment (*)		FC		Weight		Power		Current		Ia/In		II3 D	Cable
	Kgcm		Kg		Kg		Kw		A max (Y)					
	50Hz	60Hz	50Hz	60Hz	50Hz	60Hz	50 Hz	60 Hz	50 Hz	60 Hz	50Hz	60Hz	(°C)	Glande
MVE 1400/15S	108.57	76.72	1364	1388	59.8	58.2	0.90	1.10	1.71	1.78	4.00	4.00	135	M25
MVE 1700/15S	137.31	91.98	1725	1664	61.8	59.4	1.15	1.30	2.16	2.09	4.70	4.50	135	M25
MVE 2400/15S	187.69	137.36	2358	2485	68.0	62.0	1.60	1.90	3.00	3.20	4.90	4.90	135	M25
MVE 3800/15S	306.69	204.74	3853	3704	130.4	118.4	2.20	2.60	4.12	4.15	6.80	6.80	135	M32
MVE 4300/15S	343.22	240.95	4312	4359	134.4	123.6	2.50	3.00	5.70	5.80	7.00	7.20	135	M32
MVE 5500/15S	437.39	303.74	5495	5495	192.2	190.0	3.60	3.45	6.50	6.60	7.10	7.00	135	M32

TYPE	Mechanical Features						Electric Features							
	Working moment (*)		FC		Weight		Power		Current		Ia/In		II3 D	Cable
	Kgcm		Kg		Kg		Kw		A max (Δ)					
	50Hz	60Hz	50Hz	60Hz	50Hz	60Hz	50 Hz	60 Hz	50 Hz	60 Hz	50Hz	60Hz	(°C)	Glande
MVE 7200/15S	576.76	397.32	7246	7188	253.0	246.6	5.00	6.00	9.60	9.41	6.80	6.90	135	M32
MVE 9000/15S	717.97	498.76	9020	9023	268.6	258	7.50	8.50	12.00	12.00	7.00	7.00	135	M32
MVE 10000/15S	800.11	588.30	10052	10643	312	297	7.80	9.40	13.00	13.00	6.50	6.40	135	M32

(*) = Working moment = 2 x static moment

NOTE: Dimensions with coarse degree of accuracy related to UNI 22768/1

FIG.	Size	Dimensional Features																	
		C		M		M1		A	B	Ø G	Holes	D	E	F	H	I	L	N	N1
		(mm)	(mm)	(mm)	(mm)	(mm)	(mm)	(mm)	(mm)	(mm)	n°	(mm)	(mm)	(mm)	(mm)	(mm)	(mm)	(mm)	(mm)
A	60	538		98		188		140	190	17	4	229	247	30	120	247	220	222	272
A	60	538		98		188		140	190	17	4	229	247	30	120	247	220	222	272
A	60	569	538	128	98	188		140	190	17	4	229	247	30	120	247	220	222	272
A	75	677	652	140	115	229		155	255	23.5	4	302	318	35	147	295	273	264	315
A	75	677		140		229		155	255	23.5	4	302	318	35	147	295	273	264	315
A	80	695		130		222		180	280	26	4	332	360	37	167	340	304	310	361

FIG.	Size	Dimensional Features																	
		C		M		M1		A	B	Ø G	Holes	D	E	F	H	I	L	N	N1
		(mm)	(mm)	(mm)	(mm)	(mm)	(mm)	(mm)	(mm)	(mm)	(mm)	(mm)	(mm)	(mm)	(mm)	(mm)	(mm)	(mm)	(mm)
A	85	723		120		238		200	320	28	4	378	410	50	200	420	325	378	430
A	85	723		120		238		200	320	28	4	378	410	50	200	420	325	378	430
B	90	726	765	160	120	238		125	380	38	6	452	430	44	204	424	367	382	430

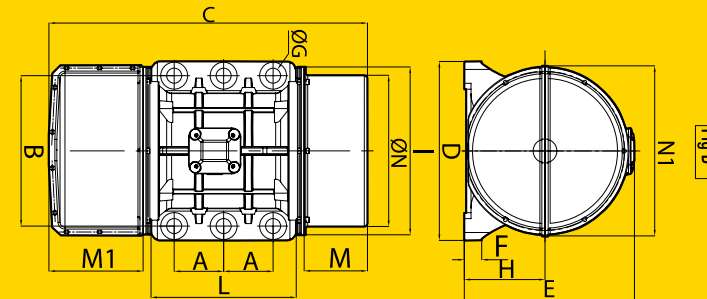
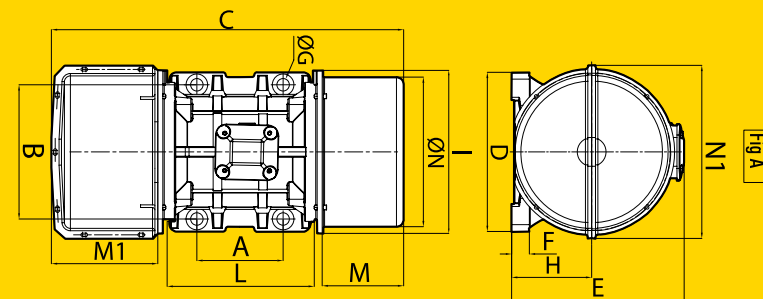
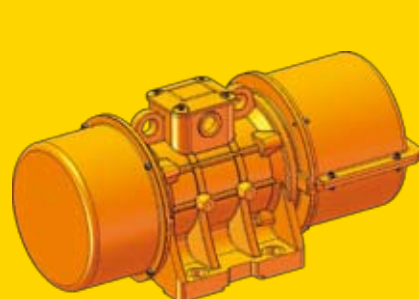

TYPE	Mechanical Features						Electric Features							
	Working moment		FC		Weight		Power		Current		Ia/In		Ex II3 D	Cable
	Kgcm		Kg		Kg		Kw		A max (Y)					
	50Hz	60Hz	50Hz	60Hz	50Hz	60Hz	50 Hz	60 Hz	50 Hz	60 Hz	50Hz	60Hz	(°C)	Glande
MVE 800/1S	137.37	108.58	767	873	61.8	59.4	0.68	0.76	1.29	1.26	2.80	2.80	135	M25
MVE 1100/1S	187.69	137.31	1048	1104	79.4	73.0	0.75	0.80	1.42	1.32	3.20	3.10	135	M25
MVE 1500/1S	284.76	196.51	1590	1580	83.6	76.5	1.10	1.30	2.10	2.00	3.30	3.30	135	M25
MVE 2600/1S	467.44	306.70	2610	2466	148.6	131.5	1.96	2.10	3.63	3.38	4.80	4.80	135	M32
MVE 3000/1S	540.33	379.71	3017	3053	155.4	137.8	2.20	2.40	4.50	4.30	5.00	5.00	135	M32
MVE 3800/1S	680.38	437.41	3799	3517	215.6	194.8	2.50	3.00	4.67	4.88	5.90	6.00	135	M32
MVE 4700/1S	838.34	584.17	4681	4697	230.8	212.4	3.20	3.90	6.50	6.00	5.50	5.70	135	M32
MVE 5200/1S	929.86	654.57	5192	5263	279.8	264.2	3.80	4.00	6.92	6.36	5.50	5.50	135	M32
MVE 6500/1S	1165.19	823.96	6506	6625	304.4	280.7	4.30	5.00	7.76	7.81	6.20	6.00	135	M32

TYPE	Mechanical Features						Electric Features							
	Working moment		FC		Weight		Power		Current		Ia/In		Ex II3 D	Cable
	Kgcm		Kg		Kg		Kw		A max (Δ)					
	50Hz	60Hz	50Hz	60Hz	50Hz	60Hz	50 Hz	60 Hz	50 Hz	60 Hz	50Hz	60Hz	(°C)	Glande
MVE 8000/1S	1435.98	929.80	8018	7476	325	290	7.10	7.50	12.60	11.60	6.00	6.20	135	M32
MVE 9000/1S	1600.39	1165.23	8936	9369	338	308	7.50	8.30	13.20	12.60	6.30	6.20	135	M32
MVE 10000/1S	1788.44	1239.98	9986	9970	386	359	7.60	8.00	13.50	12.70	6.40	6.40	135	M32

(*) = Working moment = 2 x static moment

NOTE: Dimensions with coarse degree of accuracy related to UNI 22768/1

FIG.	Size	Dimensional Features																
		C		M		M1	A	B	Ø G	Holes	D	E	F	H	I	L	N	N1
		(mm)	(mm)	(mm)	(mm)	(mm)	(mm)	(mm)	(mm)	n°	(mm)	(mm)	(mm)	(mm)	(mm)	(mm)	(mm)	(mm)
A	60	538		98		188	140	190	17	4	229	247	30	120	245	220	222	272
A	60	569	538	129	98	188	140	190	17	4	229	247	30	120	245	220	222	272
A	60	596	569	188	128	188	140	190	17	4	229	247	30	120	235	220	222	272
A	75	737		200		229	155	255	23.5	4	302	318	35	147	295	273	265	315
A	75	737		200		229	155	255	23.5	4	302	318	35	147	295	273	265	315
A	80	683	695	170	130	222	180	280	26	4	332	360	37	167	340	304	310	361
A	80	760	683	195	170	222	180	280	26	4	332	360	37	167	340	304	310	361
A	85	770	723	160	120	238	200	320	28	4	378	410	50	200	420	325	378	430
A	85	763	770	160		238	200	320	28	4	378	410	50	200	420	325	378	430

FIG.	Size	Dimensional Features																
		C		M		M1	A	B	Ø G	Holes	D	E	F	H	I	L	N	N1
		(mm)	(mm)	(mm)	(mm)	(mm)	(mm)	(mm)	(mm)	(mm)	(mm)	(mm)	(mm)	(mm)	(mm)	(mm)	(mm)	(mm)
A	85	785	770	210	160	238	200	320	28	4	378	410	50	200	420	325	378	430
A	85	785	763	210	160	238	200	320	28	4	378	410	50	200	420	325	378	430
B	90	855				238	125	380	38	6	452	430	44	204	424	367	378	430

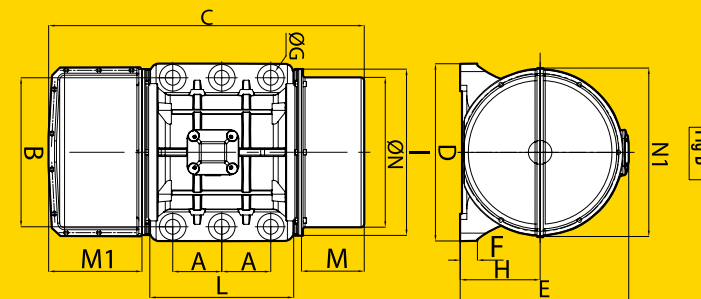
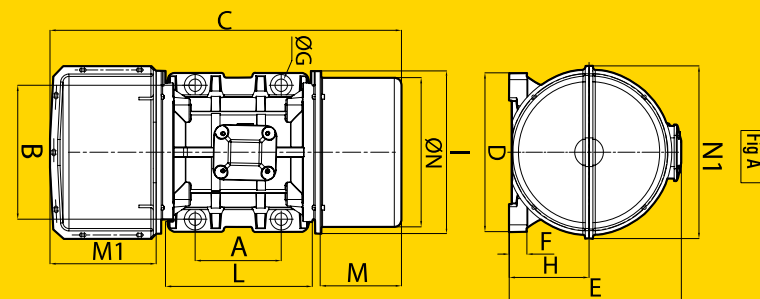
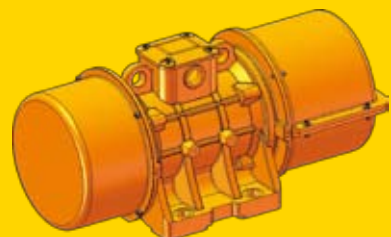

TYPE	Mechanical Features				Electric Features							
	Working moment (*) Kgcm 50Hz - 60Hz	FC Kg		Weight Kg 50Hz - 60Hz	Power Kw		Current A max (Y)		Ia/In		Ex II 3 D Temp. Class (°C)	Cable Glande Class Temp
		50Hz	60Hz		50 Hz	60 Hz	50Hz	60Hz	50Hz	60Hz		
MVE 650/075S	137.31	431	621	64.7	0.50	0.60	1.20	1.20	2.20	2.20	135	M25
MVE 900/075S	187.72	589	849	71.0	0.65	0.78	1.23	1.29	2.50	2.50	135	M25
MVE 2100/075S	467.41	1468	2114	150.4	1.50	1.80	2.81	2.89	4.20	4.10	135	M32
MVE 3100/075S	680.34	2137	3077	212.2	2.00	2.30	3.79	3.77	4.00	4.00	135	M32
MVE 3800/075S	838.43	2633	3792	230.2	2.50	3.00	6.00	6.00	3.90	4.00	135	M32
MVE 4200/075S	929.74	2920	4205	284.5	2.90	3.40	6.50	6.50	3.80	3.70	135	M32
MVE 5300/075S	1165.22	3660	5270	305	4.00	4.30	8.50	8.00	3.80	4.20	135	M32
MVE 6500/075S	1435.85	4510	6494	324.4	5.00	5.90	10.00	10.00	3.60	4.00	135	M32

(*) = Working moment = 2 x static moment

TYPE	Dimensional Features																
	FIG.	Size	C	M	M1	A	B	Ø G	Holes	D	E	F	H	I	L	N	N1
			(mm) 50Hz - 60Hz	(mm) 50Hz - 60Hz	(mm) 50Hz - 60Hz	(mm)	(mm)	(mm)	n°	(mm)	(mm)	(mm)	(mm)	(mm)	(mm)	(mm)	(mm)
MVE 650/075S	A	60	569	128	188	140	190	17	4	229	247	30	120	245	220	222	272
MVE 900/075S	A	60	569	128	188	140	190	17	4	229	247	30	120	245	220	222	272
MVE 2100/075S	A	75	737	200	229	155	255	23.5	4	302	318	35	147	295	273	265	315
MVE 3100/075S	A	80	683	170	222	180	280	26	4	332	360	37	167	340	304	310	361
MVE 3800/075S	A	80	760	195	222	180	280	26	4	332	360	37	167	340	304	310	361
MVE 4200/075S	A	85	770	160	238	200	320	28	4	378	410	50	200	420	325	378	420
MVE 5300/075S	A	85	763	160	238	200	320	28	4	378	410	50	200	420	325	378	420
MVE 6500/075S	A	85	785	210	238	200	320	28	4	378	410	50	200	420	325	378	420

NOTE: Dimensions with coarse degree of accuracy related to UNI 22768/1

